

PART LIST

ENG: Below you will find a list of all parts that come with each trampoline modell. If you find any piece is missing please contact your local dealer.

SV: Nedanför hittar du en lista med alla olika delar för varje studsmattemodell. Skulle du sakna någon del så var vänlig och kontakta er närmaste återförsäljare.

NO: Nedenfor vil du finne en liste over alle deler som følger med de ulike trampoline-modellene. Hvis du oppdager at noe mangler vennligst ta kontakt med din lokale forhandler.

DK: Nedenfor finder du en liste over alle dele, der kommer med de forskellige trampolin modeller. Hvis du opdager, at der mangler noget, skal du kontakte din lokale forhandler.

FI: Alla esitetään luettelo kaikista osista, jotka toimitetaan jokaisen trampoliinimallin ohessa. Jos havaitset, että jokin osa puuttuu, ota yhteyttä paikalliseen jälleenmyyjään.

DE: Nachfolgend finden Sie eine Liste, die alle Teile ihres Trampolin-Modelles umfasst. Sollten Sie feststellen, dass ein Teil fehlt, schreiben Sie es in dieses Dokument, scannen Sie es und lassen es Ihren lokalen Händler zukommen.

TRAMPOLINE	ADVENTURER 350 + SAFETY NET			ADVENTURER 420 + SAFETY NET			ADVENTURER 500 + SAFETY NET			ADVENTURER 350 + SICHERHEITSNETZ		ADVENTURER 420 + SICHERHEITSNETZ		ADVENTURER 500 + SICHERHEITSNETZ	
	TOP RAIL	8 PCS		TOP RAIL	8 PCS		TOP RAIL	8 PCS		OBERRAHMEN	8 STK	OBERRAHMEN	8 STK	OBERRAHMEN	8 STK
	MIDDLE POST	8 PCS		MIDDLE POST	8 PCS		MIDDLE POST	8 PCS		MITTELPFOSTEN	8 STK	MITTELPFOSTEN	8 STK	MITTELPFOSTEN	8 STK
	LOWER LEG	4 PCS		LOWER LEG	4 PCS		LOWER LEG	4 PCS		UNTERESBEIN	4 STK	UNTERESBEIN	4 STK	UNTERESBEIN	4 STK
	SPRING	56 PCS		SPRING	72 PCS		SPRING	88 PCS		FEDER	56 STK	FEDER	72 STK	FEDER	88 STK
	FRAME PADDING	1 PCS		FRAME PADDING	1 PCS		FRAME PADDING	1 PCS		RAHMENPOLSTERUNG	1 STK	RAHMENPOLSTERUNG	1 STK	RAHMENPOLSTERUNG	1 STK
	JUMP MAT	1 PCS		JUMP MAT	1 PCS		JUMP MAT	1 PCS		SPRUNGMATTE	1 STK	SPRUNGMATTE	1 STK	SPRUNGMATTE	1 STK
	SPRING ASSEMBLY TOOL	1 PCS		SPRING ASSEMBLY TOOL	1 PCS		SPRING ASSEMBLY TOOL	1 PCS		FEDERMONTAGWERKZEUG	2 STK	FEDERMONTAGWERKZEUG	2 STK	FEDERMONTAGWERKZEUG	2 STK
	FRAME PADDING ENTRANCE	1 PCS		FRAME PADDING ENTRANCE	1 PCS		FRAME PADDING ENTRANCE	1 PCS		EINGANGPOLSTERUNG	1 STK	EINGANGPOLSTERUNG	1 STK	EINGANGPOLSTERUNG	1 STK
	ELASTIC STRAP	17 PCS		ELASTIC STRAP	17 PCS		ELASTIC STRAP	17 PCS		GUMMIBAND	17 STK	GUMMIBAND	17 STK	GUMMIBAND	17 STK
ASSEMBLY MANUAL	1 PCS		ASSEMBLY MANUAL	1 PCS		ASSEMBLY MANUAL	1 PCS		MONTAGEANLEITUNG	1 STK	MONTAGEANLEITUNG	1 STK	MONTAGEANLEITUNG	1 STK	

SAFETY NET	SAFETY NET POLE	16 PCS	SAFETY NET POLE	16 PCS	SAFETY NET POLE	16 PCS	SICHERHEITSNETZPFOSTEN	16 PCS	SICHERHEITSNETZPFOSTEN	16 PCS	SICHERHEITSNETZPFOSTEN	16 PCS
	POLE FOAM	16 PCS	POLE FOAM	16 PCS	POLE FOAM	16 PCS	PFOSTENSCHAUMSTOFFPOLSTER	16 STK	PFOSTENSCHAUMSTOFFPOLSTER	16 STK	PFOSTENSCHAUMSTOFFPOLSTER	16 STK
	SAFETY NET	1 PCS	SAFETY NET	1 PCS	SAFETY NET	1 PCS	SICHERHEITSNETZ	1 STK	SICHERHEITSNETZ	1 STK	SICHERHEITSNETZ	1 STK
	TOP CAP	8 PCS	TOP CAP	8 PCS	TOP CAP	8 PCS	ABSCHLUSSKAPPE	8 STK	ABSCHLUSSKAPPE	8 STK	ABSCHLUSSKAPPE	8 STK
	STEEL RIM	7 PCS	STEEL RIM	7 PCS	STEEL RIM	7 PCS	STAHLUMRANDUNG	7 STK	STAHLUMRANDUNG	7 STK	STAHLUMRANDUNG	7 STK
	STEEL RIM WITH FIBERGLASS	1 PCS	STEEL RIM WITH FIBERGLASS	1 PCS	STEEL RIM WITH FIBERGLASS	1 PCS	STAHLUMRANDUNG MIT GLASFASER	1 STK	STAHLUMRANDUNG MIT GLASFASER	1 STK	STAHLUMRANDUNG MIT GLASFASER	1 STK
	POLE SLEEVE	7 PCS	POLE SLEEVE	7 PCS	POLE SLEEVE	7 PCS	SCHUTZHÜLLE	7 PCS	SCHUTZHÜLLE	7 PCS	SCHUTZHÜLLE	7 PCS
	TOP CAP SCREWS	8 PCS	TOP CAP SCREWS	8 PCS	TOP CAP SCREWS	8 PCS	ABSCHLUSSKAPPENSCHRAUBEN	8 STK	ABSCHLUSSKAPPENSCHRAUBEN	8 STK	ABSCHLUSSKAPPENSCHRAUBEN	8 STK
	TOP CAP TOOL	1 PCS	TOP CAP TOOL	1 PCS	TOP CAP TOOL	1 PCS	WERKZEUG FÜR ABSCHLUSSKAPPE	1 STK	WERKZEUG FÜR ABSCHLUSSKAPPE	1 STK	WERKZEUG FÜR ABSCHLUSSKAPPE	1 STK
	SPRING GUARD STRAP	2 PCS	SPRING GUARD STRAP	2 PCS	SPRING GUARD STRAP	2 PCS	FEDERSCHUTZ	2 STK	FEDERSCHUTZ	2 STK	FEDERSCHUTZ	2 STK
ELASTIC STRAP LONG	1 PCS	ELASTIC STRAP LONG	1 PCS	ELASTIC STRAP LONG	1 PCS	GUMMIBAND LANG	1 STK	GUMMIBAND LANG	1 STK	GUMMIBAND LANG	1 STK	

BOX CONTENT

BOX 1

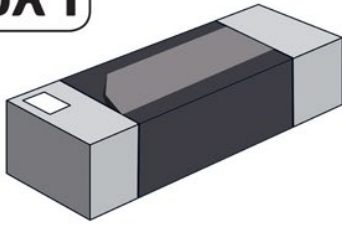

SAFETY NET 1X
SICHERHEITSNETZ 1X

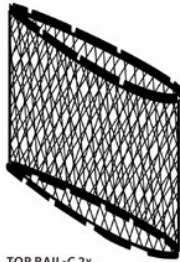

TOP RAIL-C 2x
OBERRAHMEN-C 2X



TOP RAIL-A 2x
OBERRAHMEN-A 2X



TOP RAIL-B 4x
OBERRAHMEN-B 4X



SPRING TOOL 1X
FEDERMONTAGEWERKZEUG 1X



SPRINGS 56/72/ 88X
FEDERN 56/72/88X



FRAME PADDING 2X
RAHMENPOLSTERUNG 2X

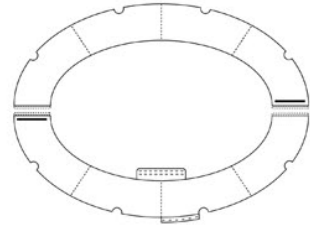

JUMP MAT 1X
SPRUNGMATTE 1X



ELASTIC STRAP 17X
GUMMIBAND 17X



ELASTIC STRAP 1X
GUMMIBAND 1X



SPRING GUARD STRAP 2X
FEDERSCHUTZBÄNDER 2X



BOX 2

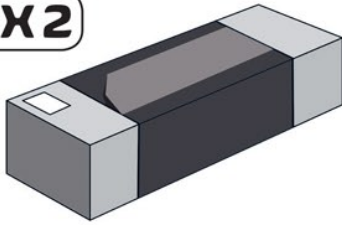

SAFETY NET POLES 16X
SICHERHEITSNETZPFOSTEN 16X

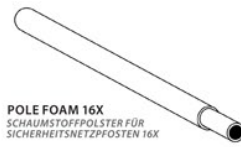

POLE FOAM 16X
SCHAUMSTOFFPOLSTER FÜR
SICHERHEITSNETZPFOSTEN 16X

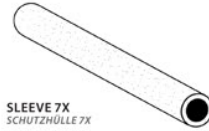

SLEEVE 7X
SCHUTZHÜLLE 7X



MIDDLE POST 8X
MITTELPFOSTEN 8X



LEGS 4X
BEINE 4X



STEEL RIM 6X
STAHLUMRANDUNG 6X



STEEL RIM WITH GLASS FIBER ROD 2X
STAHLUMRANDUNG MIT GLASFASER 2X



SCREW FOR TOP CAP 8X
ABSCHLUSSKAPPENSCHRAUBE 8X



TOP CAP 8X
ABSCHLUSSKAPPE 8X



TOOL FOR TOP CAP SCREW 1X
WERKZEUG FÜR ABSCHLUSSKAP-
PENSCHRAUBE 1X



ASSEMBLY INSTRUCTIONS

MONTAGEANLEITUNG

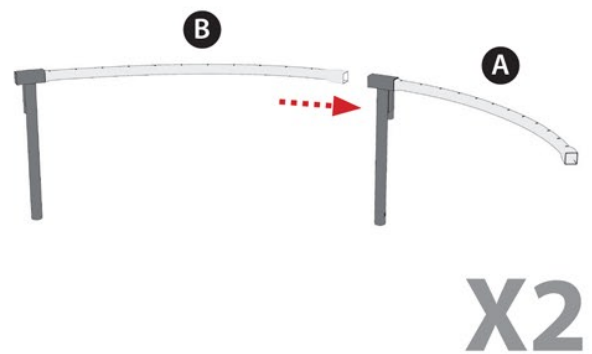
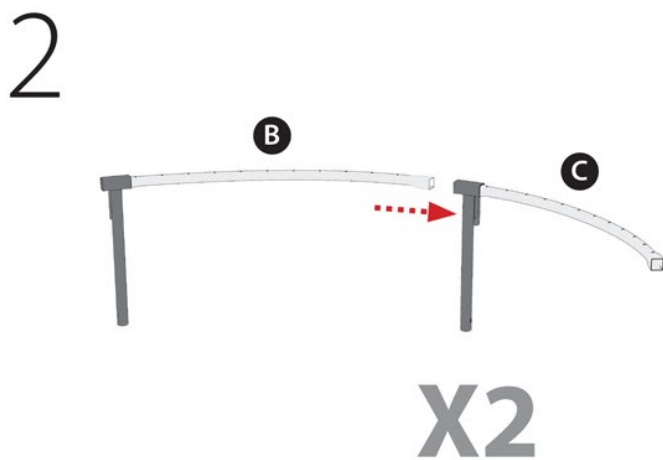
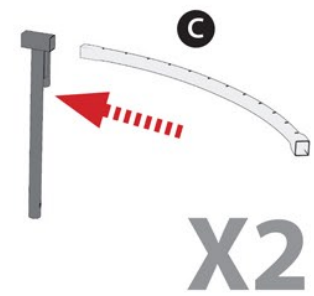
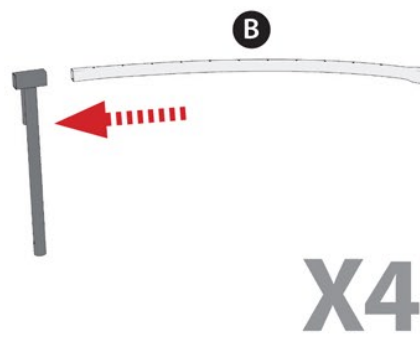
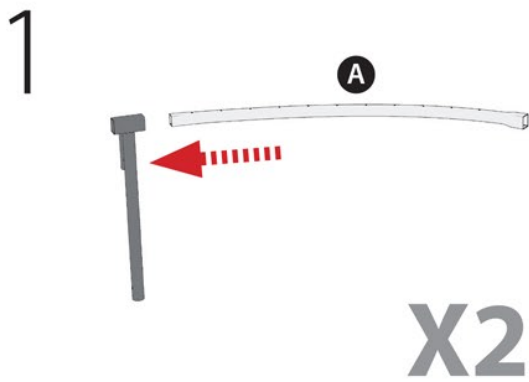
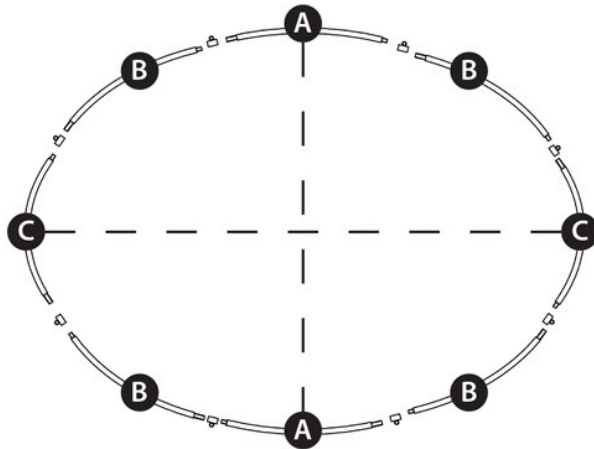
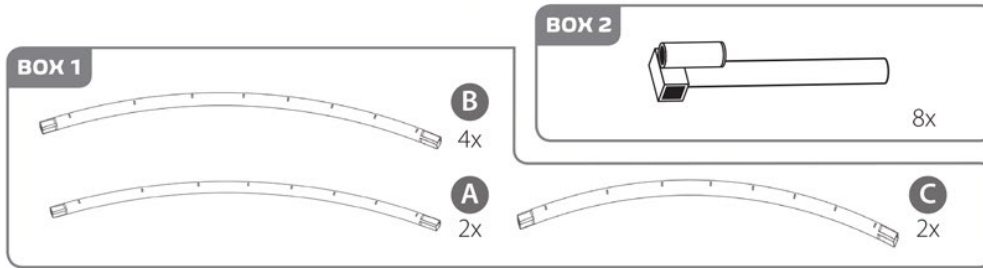

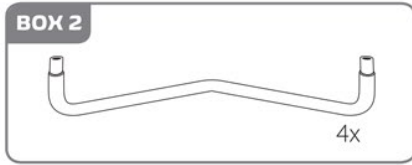

3

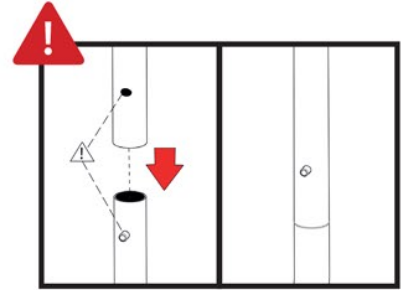
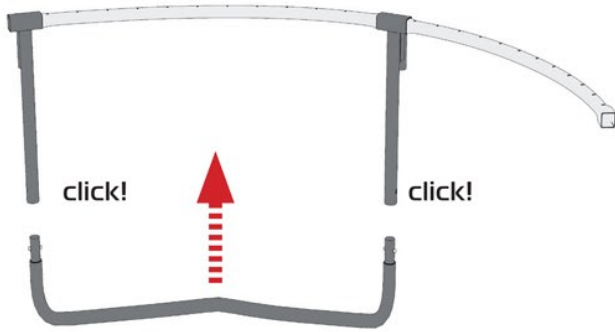

ALL

4

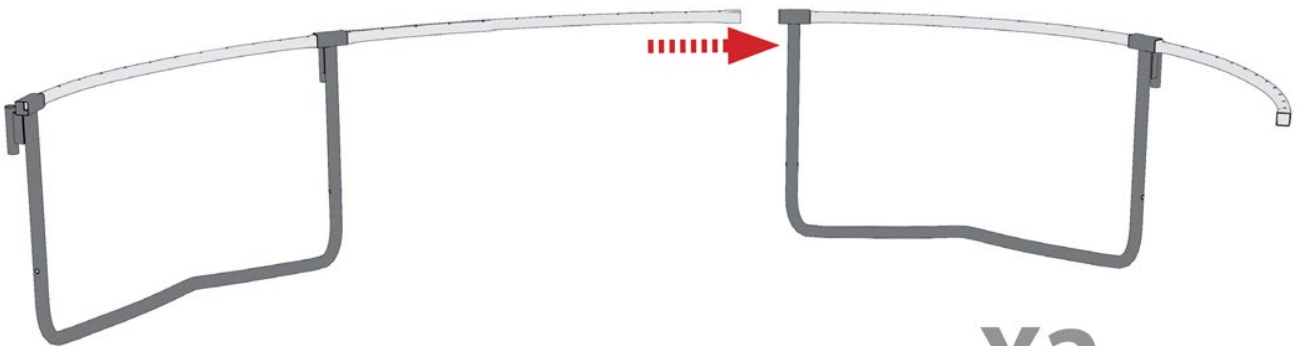

X2

5

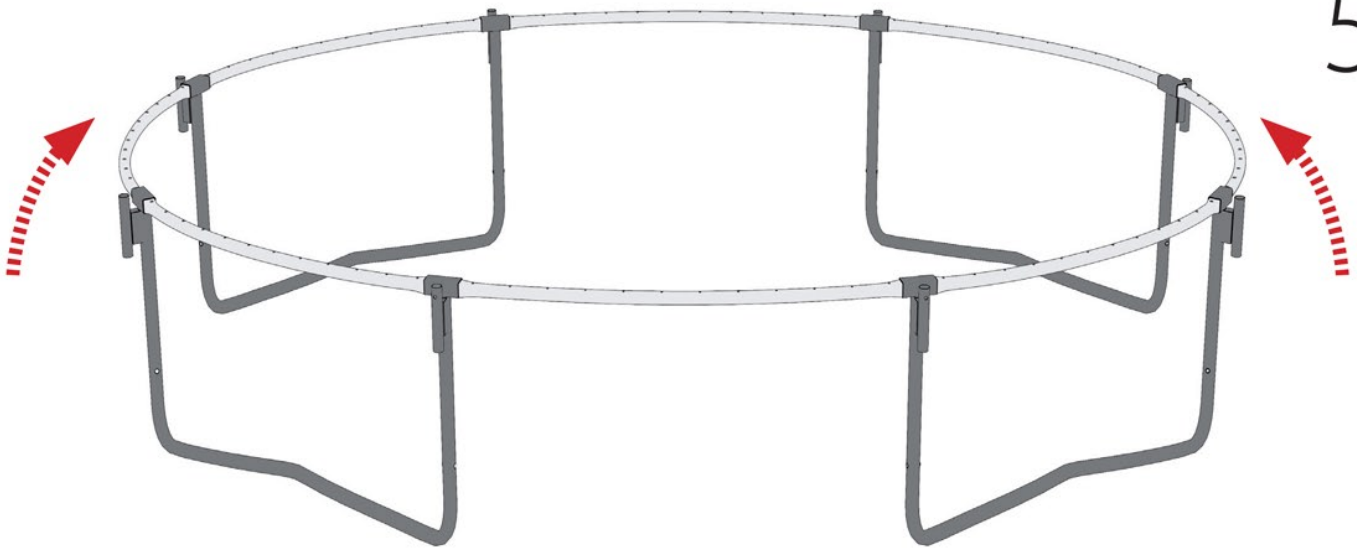

6



- ATTENTION -
 ONLY ATTACH 4x SPRINGS,
 NOT ALL DUE TO STEPS
 12-13.

- ACHTUNG -
 NUR 4 x FEDERN ANBRIN-
 GEN, NICHT ALLE AUFGR-
 UND DER SCHRITTE 12-13.

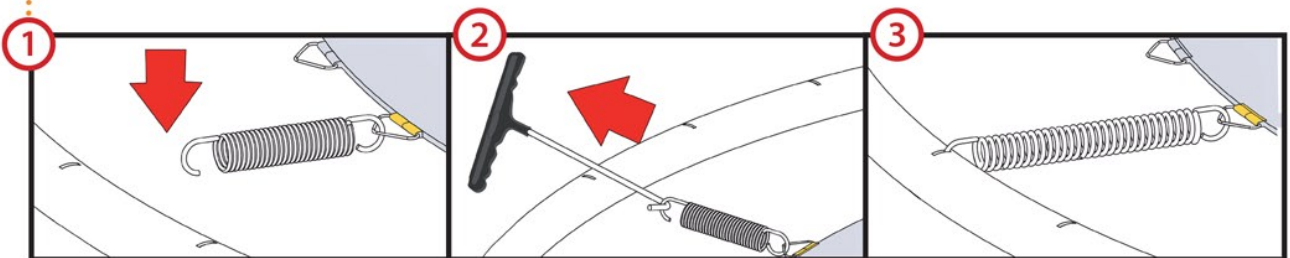
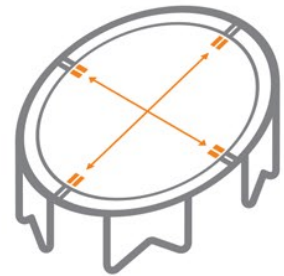
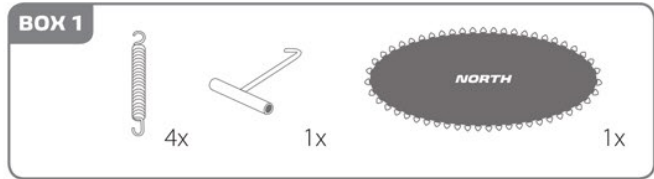

x4



7

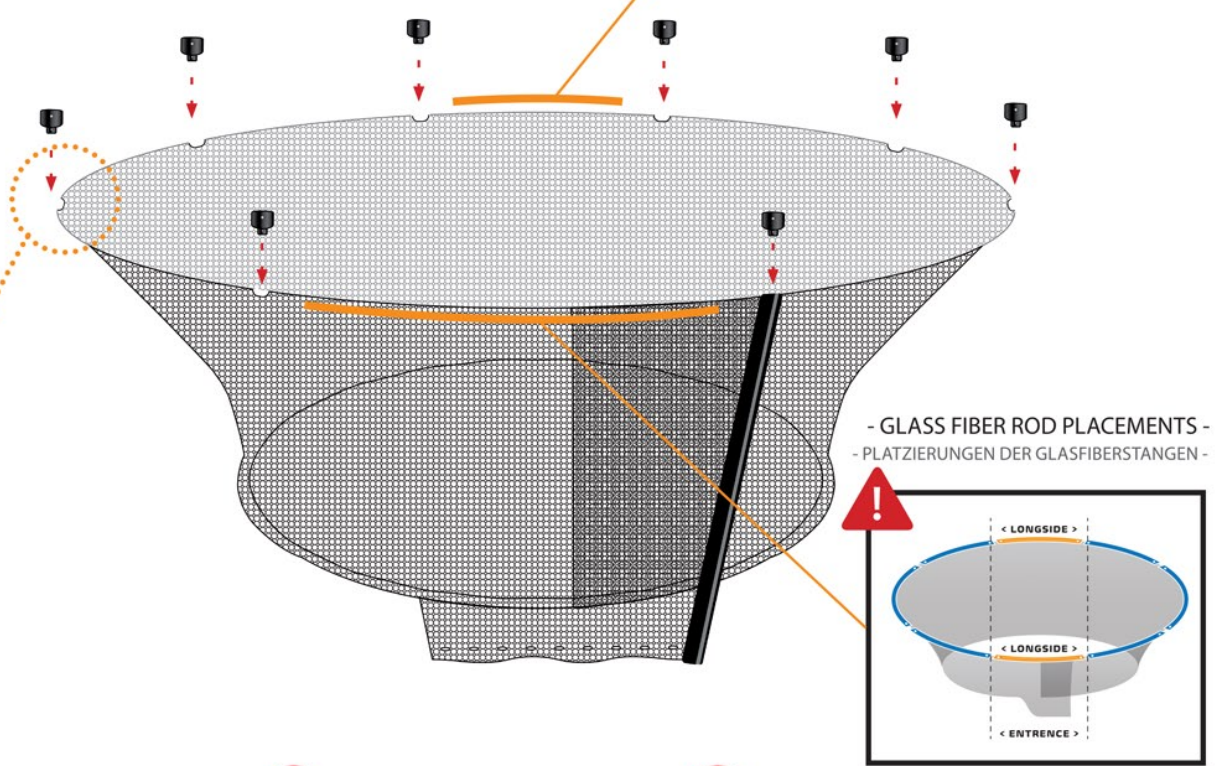
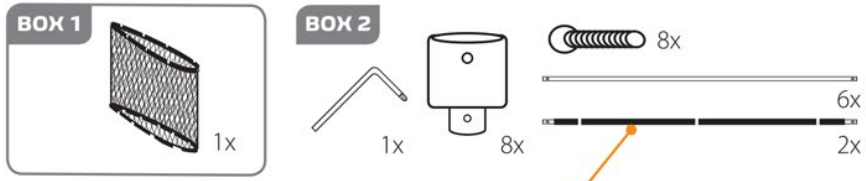

- GLASS FIBER ROD PLACEMENTS -
- PLATZIERUNGEN DER GLASFIBERSTANGEN -

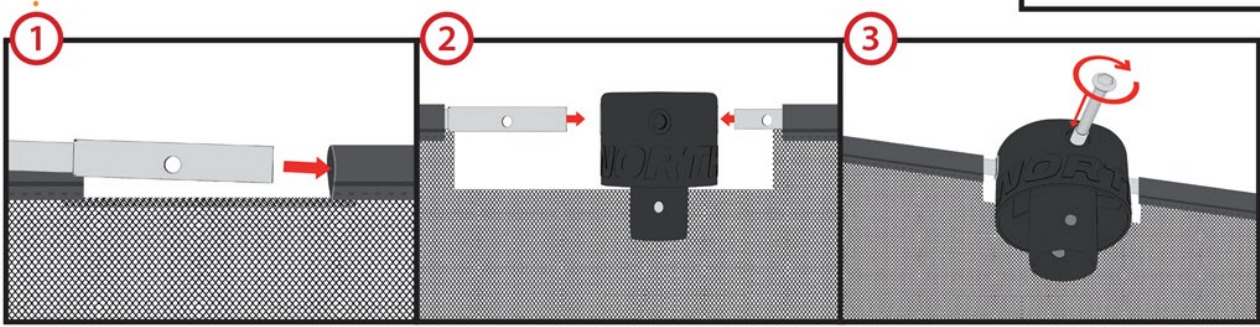

x8

8

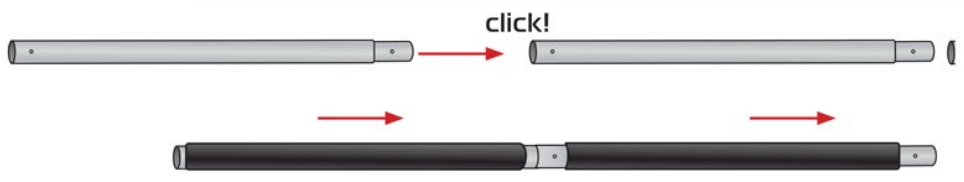
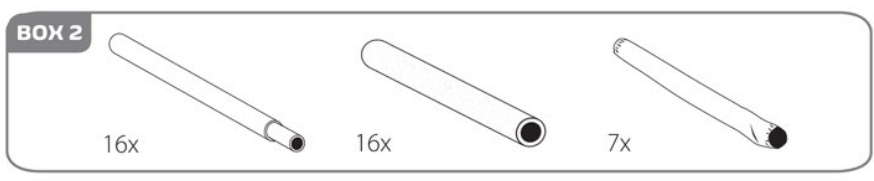

x8



x7

9



10

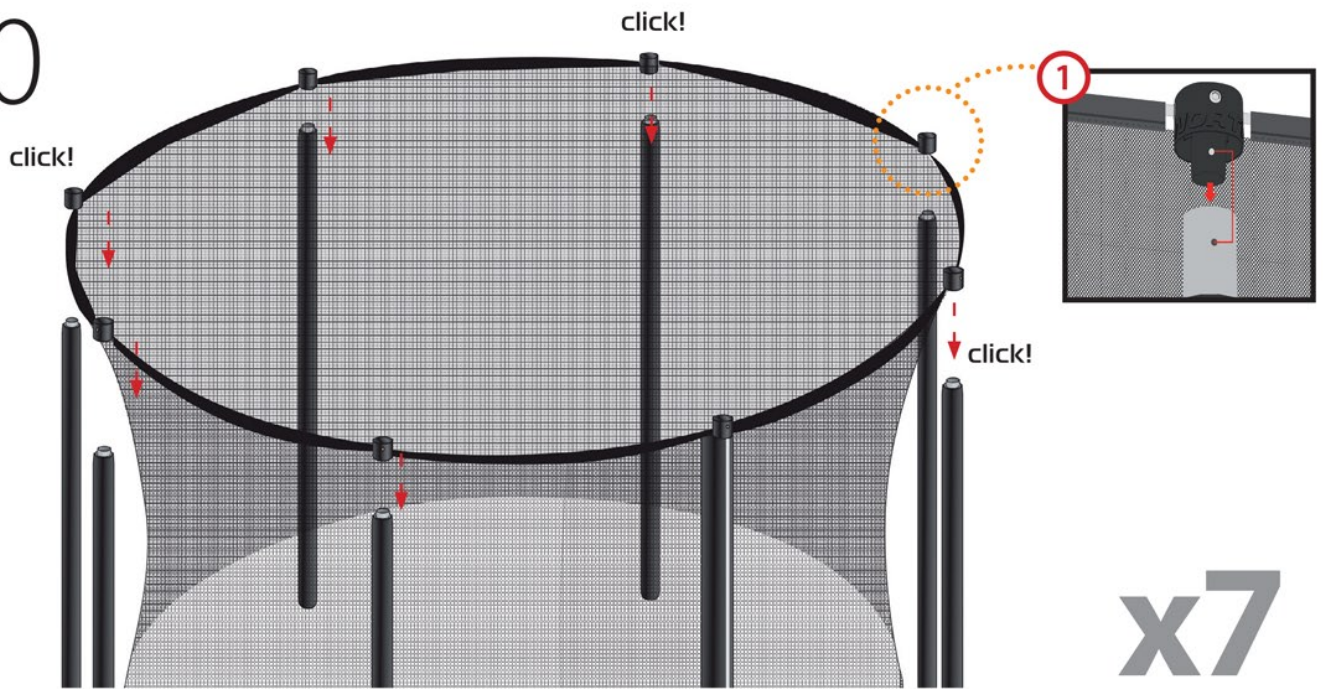

11

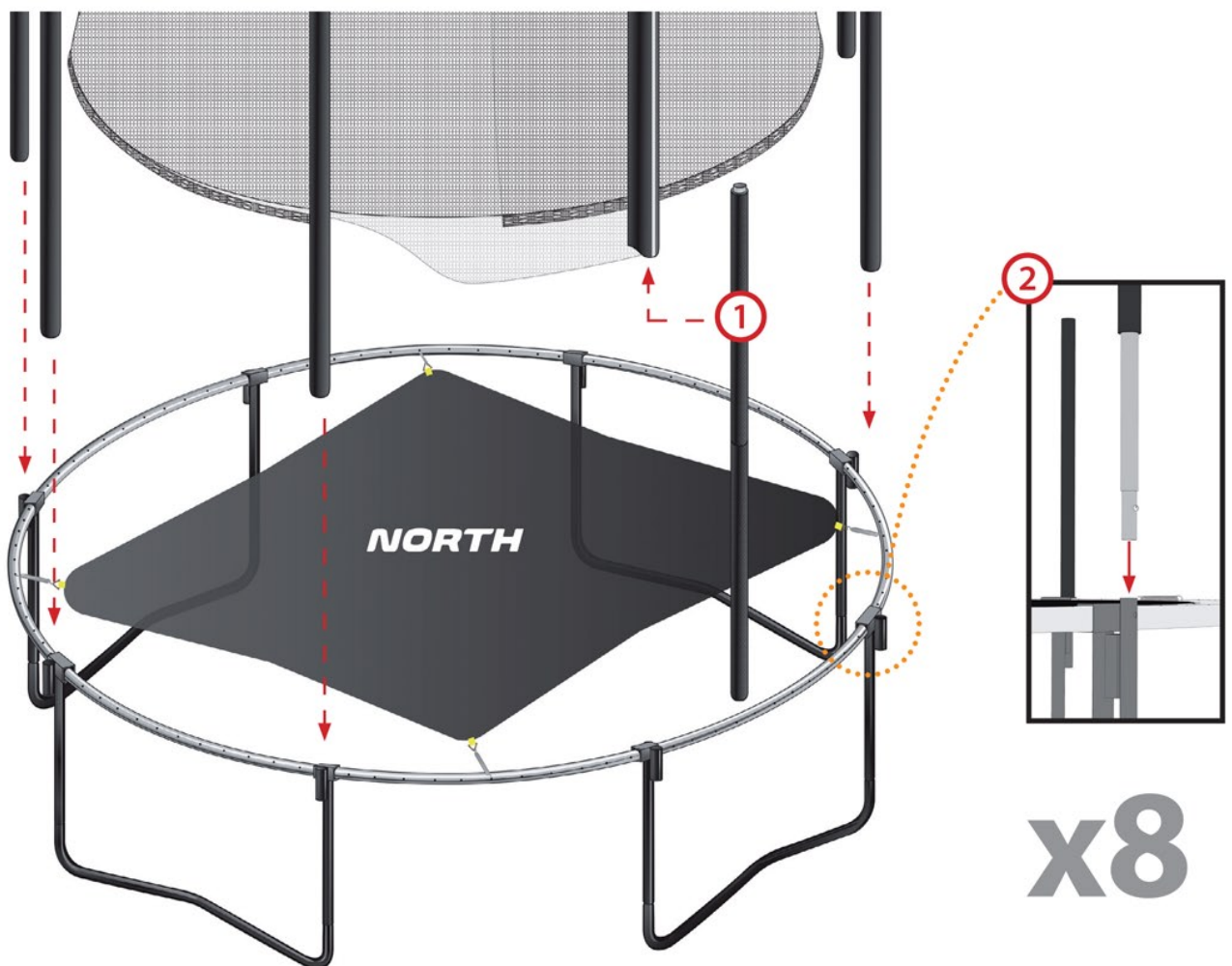

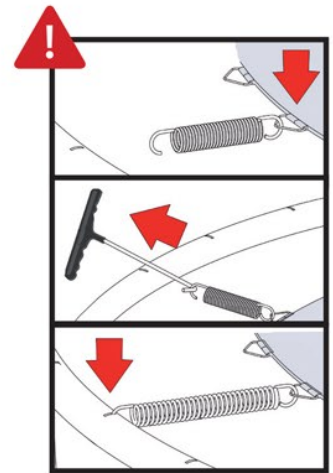
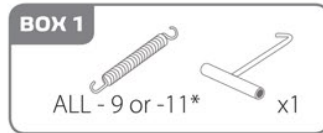
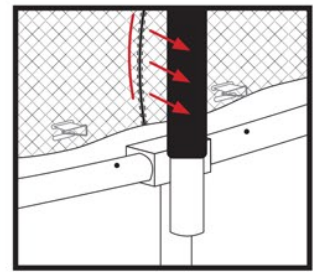
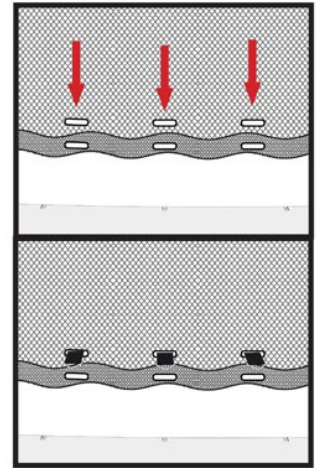

! - ATTENTION -
* LEAVE 9 or 11 SPRINGS IN THE ENTRANCE UNMOUNTED FOR LATER.

- ACHTUNG -
* LASS 9 oder 11 FEDERN BEI DER MONTAGE HIER AUS.

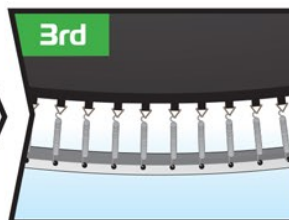
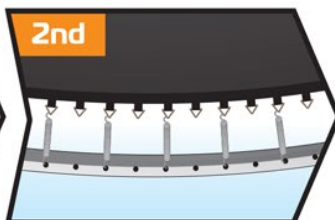
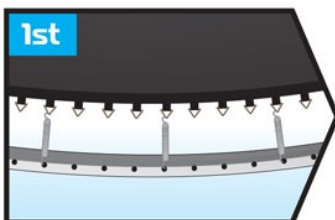

14

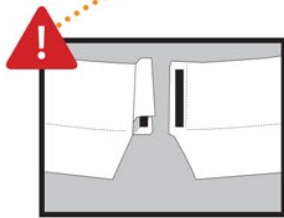
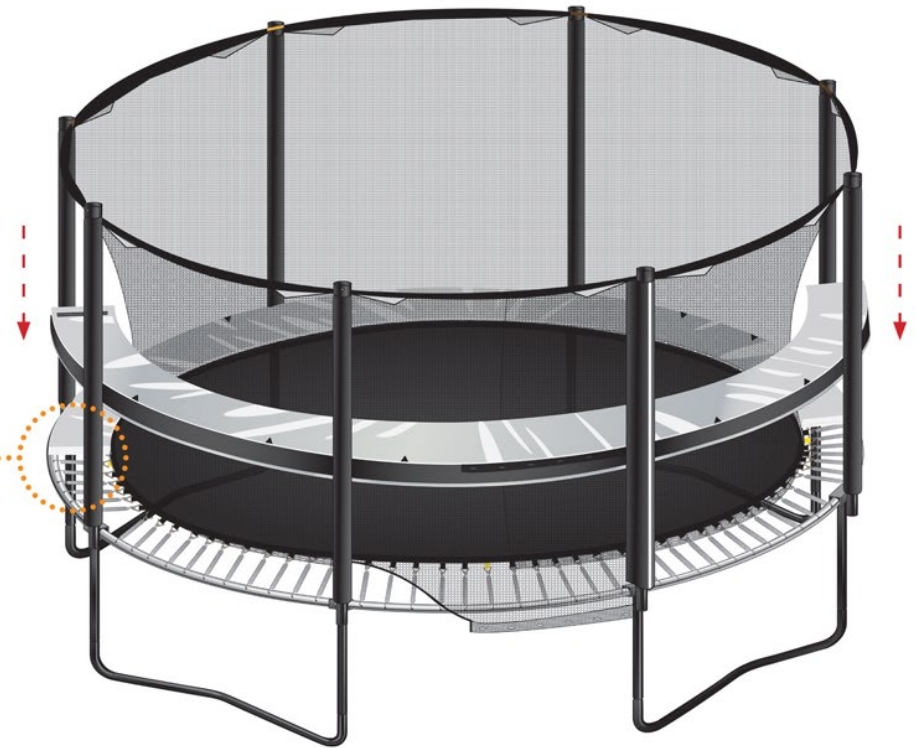
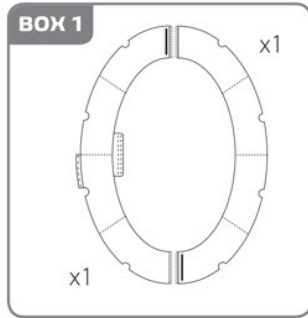

15

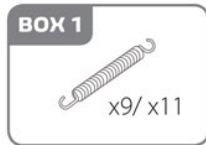

- MOUNT BELOW ENTRANCE PADDING -
- Montiere unter dem Randpolster -

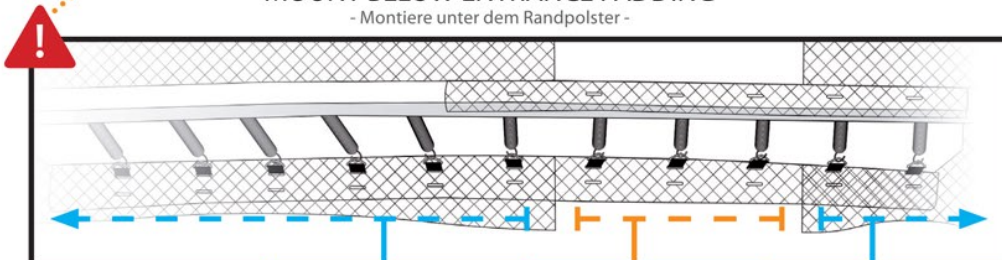

x9/ x11

MODELL:	OVERLAP LEFT	ENTRENCE	OVERLAP RIGHT	TOTAL:
ADVENTURER 500	3 SPRINGS	3 SPRINGS	3 SPRINGS	9 SPRINGS
ADVENTURER 420	2 SPRINGS	3 SPRINGS	4 SPRINGS	9 SPRINGS
ADVENTURER 350	2 SPRINGS	3 SPRINGS	6 SPRINGS	11 SPRINGS

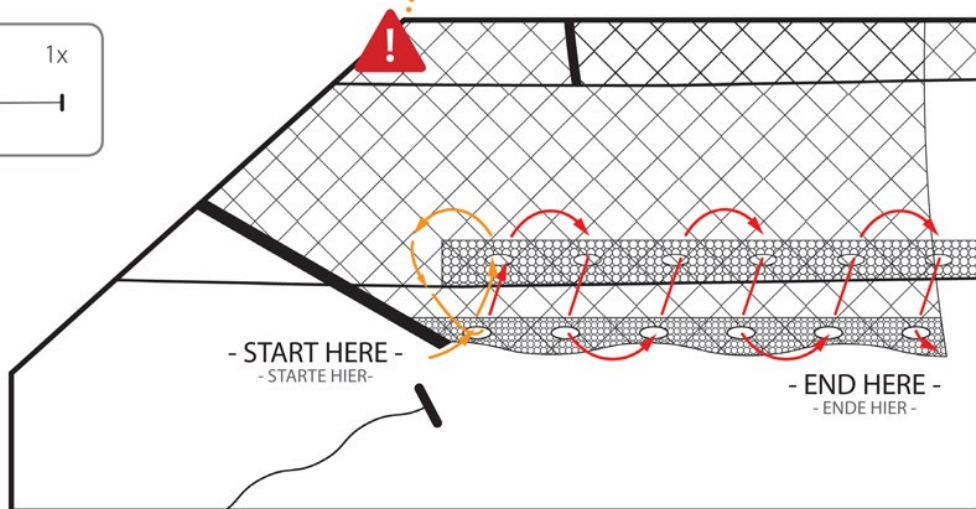
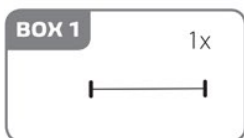
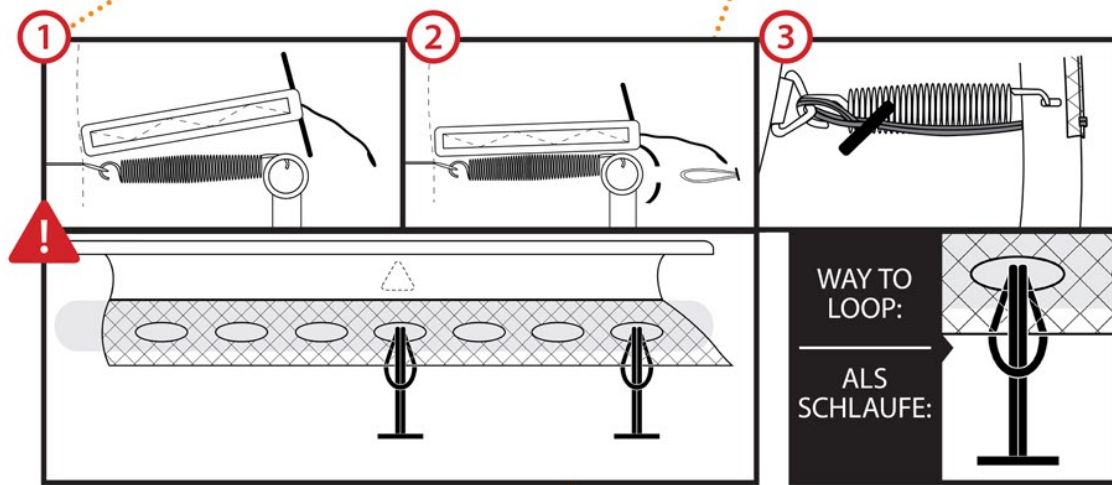
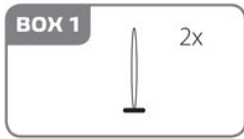

18



- STRAP ROUTE -
BANDVERLAUF

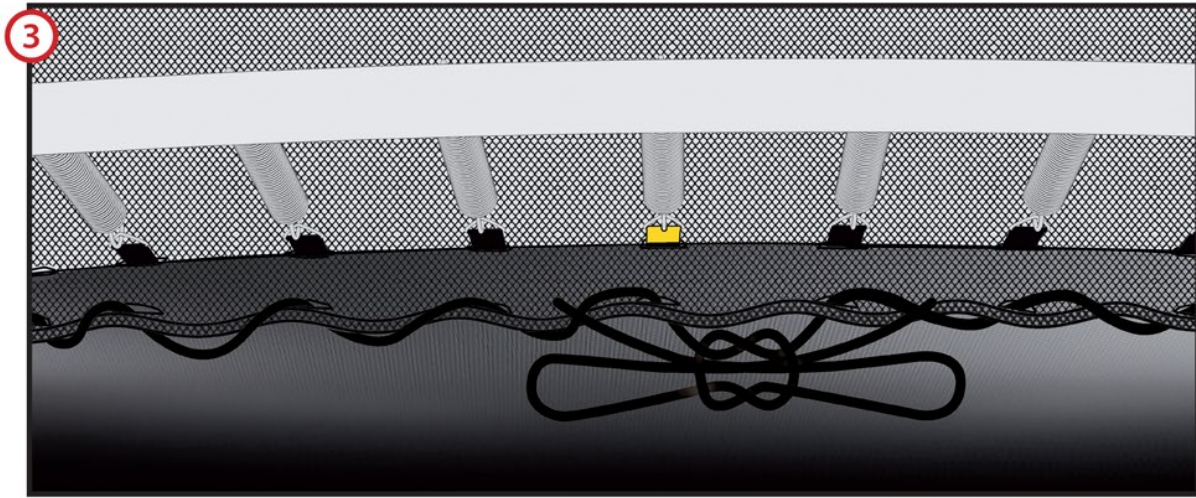
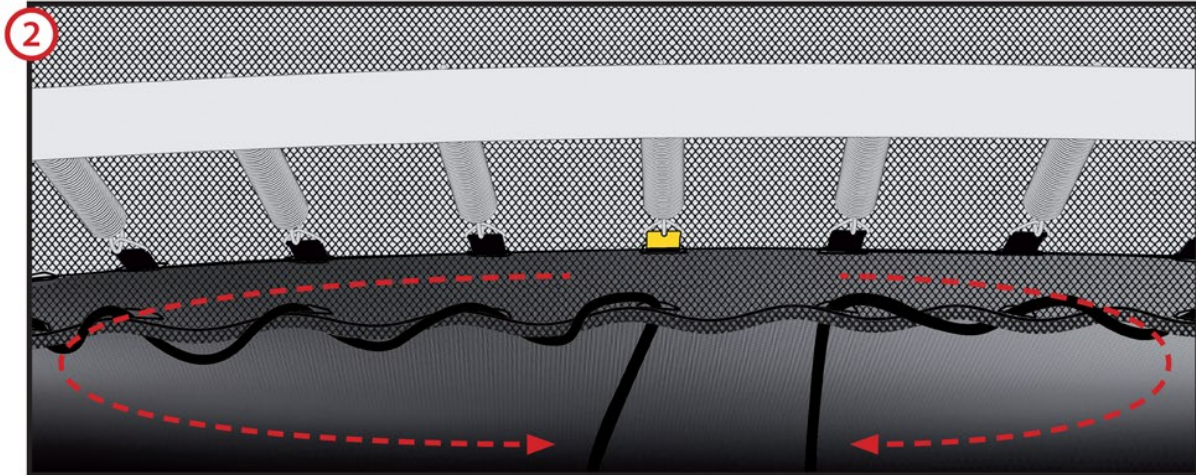
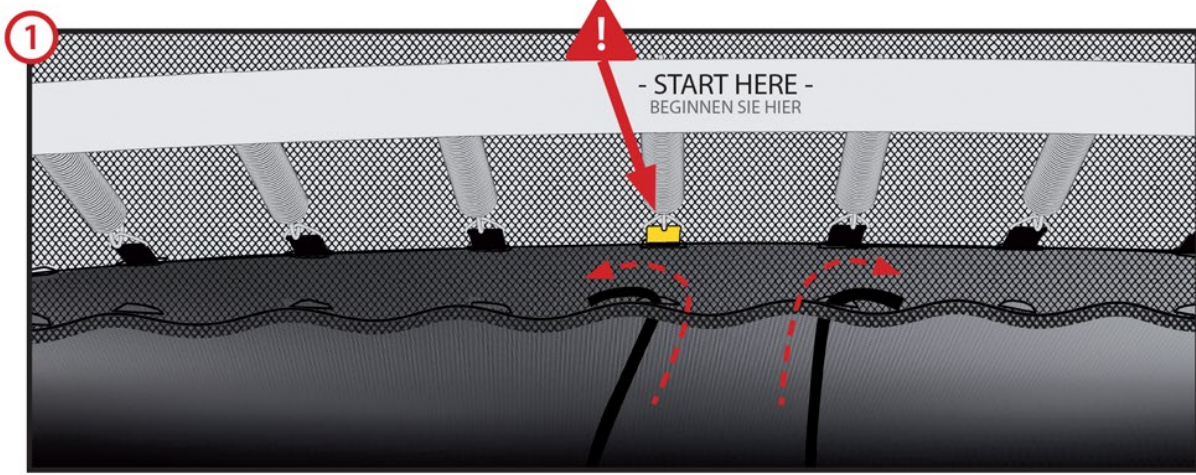
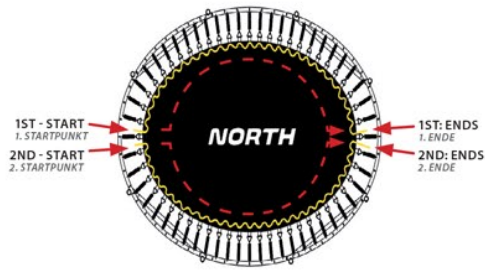

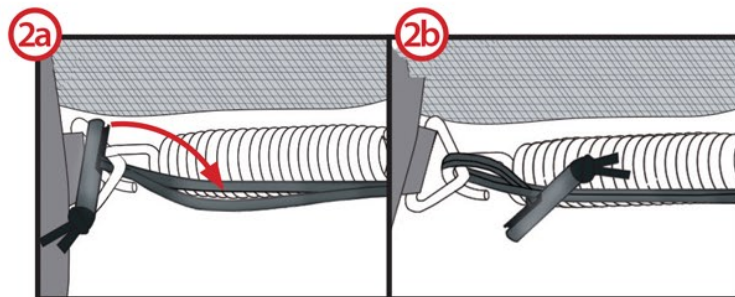
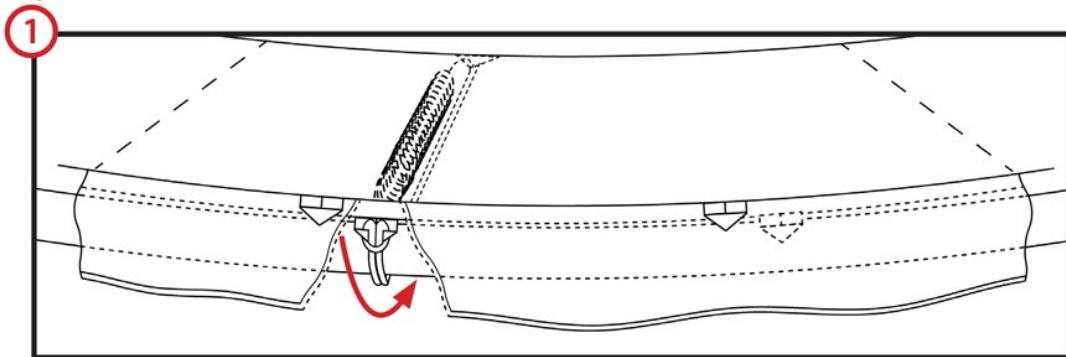
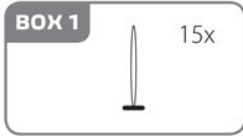

x15

