

PART LIST

ENG: Below you will find a list of all parts that come with each trampoline modell. If you find any piece is missing please contact your local dealer.

SV: Nedanför hittar du en lista med alla olika delar för varje studsmattemodell. Skulle du sakna någon del så var vänlig och kontakta er närmaste återförsäljare.

NO: Nedenfor vil du finne en liste over alle deler som følger med de ulike trampoline-modellene. Hvis du oppdager at noe mangler vennligst ta kontakt med din lokale forhandler.

DK: Nedenfor finder du en liste over alle dele, der kommer med de forskellige trampolin modeller. Hvis du opdager, at der mangler noget, skal du kontakte din lokale forhandler.

FI: Alla esitetään luettelo kaikista osista, jotka toimitetaan jokaisen trampoliinimallin ohessa. Jos havaitset, että jokin osa puuttuu, ota yhteyttä paikalliseen jälleenmyyjään.

DE: Nachfolgend finden Sie eine Liste, die alle Teile ihres Trampolin-Modelles umfasst. Sollten Sie feststellen, dass ein Teil fehlt, schreiben Sie es in dieses Dokument, scannen Sie es und lassen es Ihren lokalen Händler zukommen.

	CHALLENGER 300 + SAFETY NET		CHALLENGER 360 + SAFETY NET		CHALLENGER 430 + SAFETY NET	
TRAMPOLINE	TOP RAIL	8 PCS	TOP RAIL	8 PCS	TOP RAIL	8 PCS
	TOP RAIL FOAM	8 PCS	TOP RAIL FOAM	8 PCS	TOP RAIL FOAM	8 PCS
	FOAM STRAP	16 PCS	FOAM STRAP	16 PCS	FOAM STRAP	16 PCS
	MIDDLE POST	8 PCS	MIDDLE POST	8 PCS	MIDDLE POST	8 PCS
	LOWER LEG	4 PCS	LOWER LEG	4 PCS	LOWER LEG	4 PCS
	SPRING	64 PCS	SPRING	80 PCS	SPRING	96 PCS
	SPRING EXTENSION	64 PCS	SPRING EXTENSION	80 PCS	SPRING EXTENSION	96 PCS
	FRAME PADDING	1 PCS	FRAME PADDING	1 PCS	FRAME PADDING	1 PCS
	JUMP MAT	1 PCS	JUMP MAT	1 PCS	JUMP MAT	1 PCS
	GREASE BOTTLE	1 PCS	GREASE BOTTLE	1 PCS	GREASE BOTTLE	1 PCS
	SPRING ASSEMBLY TOOL	1 PCS	SPRING ASSEMBLY TOOL	1 PCS	SPRING ASSEMBLY TOOL	1 PCS
	ASSEMBLY MANUAL	1 PCS	ASSEMBLY MANUAL	1 PCS	ASSEMBLY MANUAL	1 PCS
	HPS JUMPMAT STRAND	4 PCS	HPS JUMPMAT STRAND	4 PCS	HPS JUMPMAT STRAND	4 PCS

SAFETY NET	SAFETY NET, UPPER POLE	8 PCS	SAFETY NET, UPPER POLE	8 PCS	SAFETY NET, UPPER POLE	8 PCS
	SAFETY NET, LOWER POLE	8 PCS	SAFETY NET, LOWER POLE	8 PCS	SAFETY NET, LOWER POLE	8 PCS
	POLE FOAM	16 PCS	POLE FOAM	16 PCS	POLE FOAM	16 PCS
	POLE SLEEVE	8 PCS	POLE SLEEVE	8 PCS	POLE SLEEVE	8 PCS
	SAFETY NET	1 PCS	SAFETY NET	1 PCS	SAFETY NET	1 PCS
	TOP CAP	8 PCS	TOP CAP	8 PCS	TOP CAP	8 PCS
	BOTTOM POLE PLUG	8 PCS	BOTTOM POLE PLUG	8 PCS	BOTTOM POLE PLUG	8 PCS
	FIBERGLASS ROD	10 PCS	FIBERGLASS ROD	12 PCS	FIBERGLASS ROD	14 PCS
	HPS SAFETY NET STRAND	4 PCS	HPS SAFETY NET STRAND	4 PCS	HPS SAFETY NET STRAND	4 PCS

BOX CONTENT

BOX 1

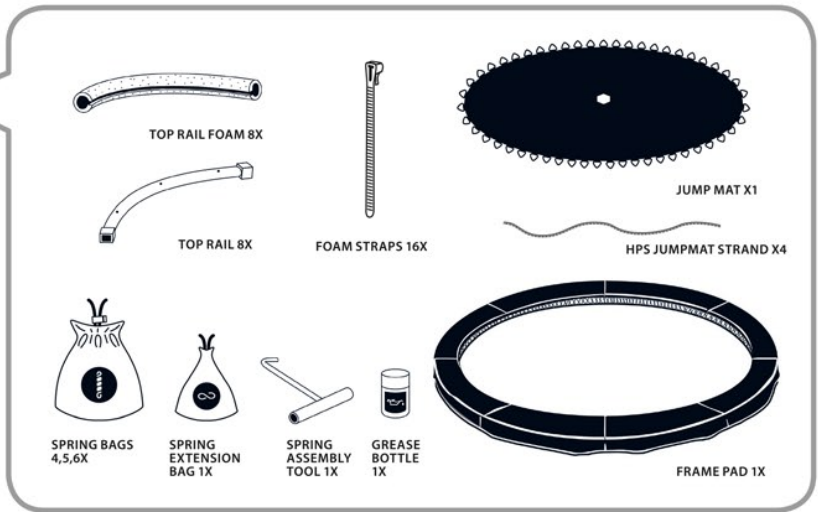
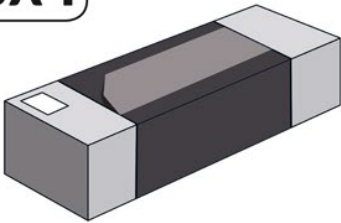

BOX 2

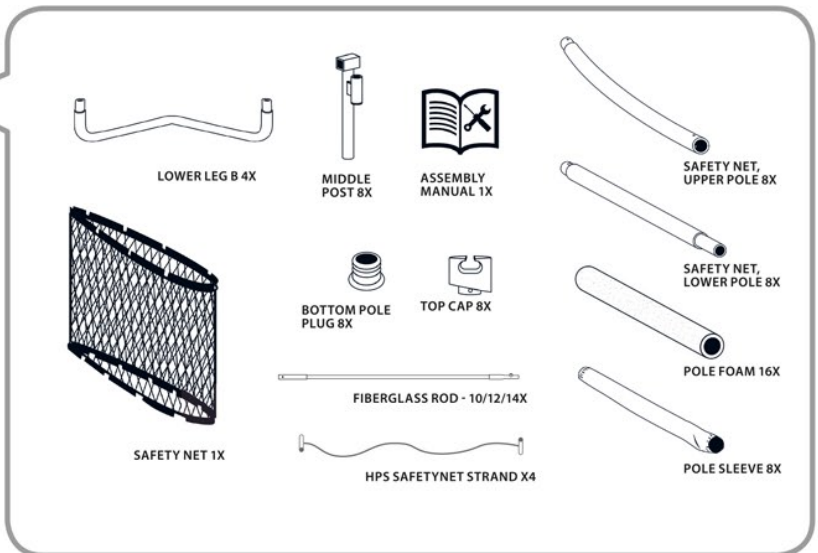
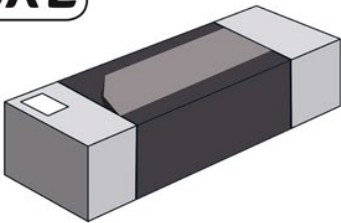

ASSEMBLY INSTRUCTIONS

1

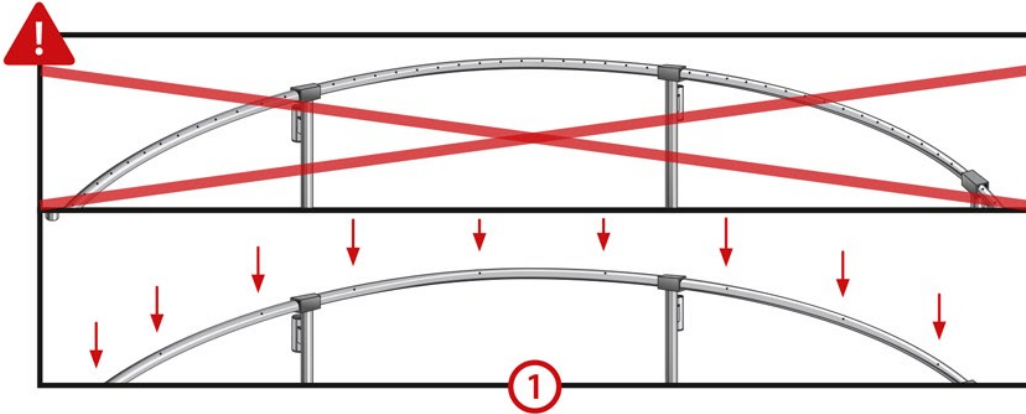
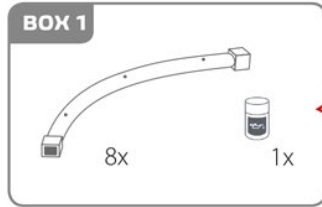
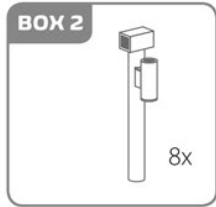

- CHOOSE THIS SIDE UP -
WÄHLE DIESE SEITE OBEN

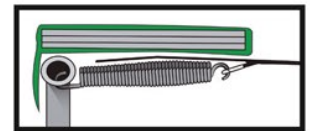

- CHOOSE LEG POSITION -
WÄHLE BEIN POSITION

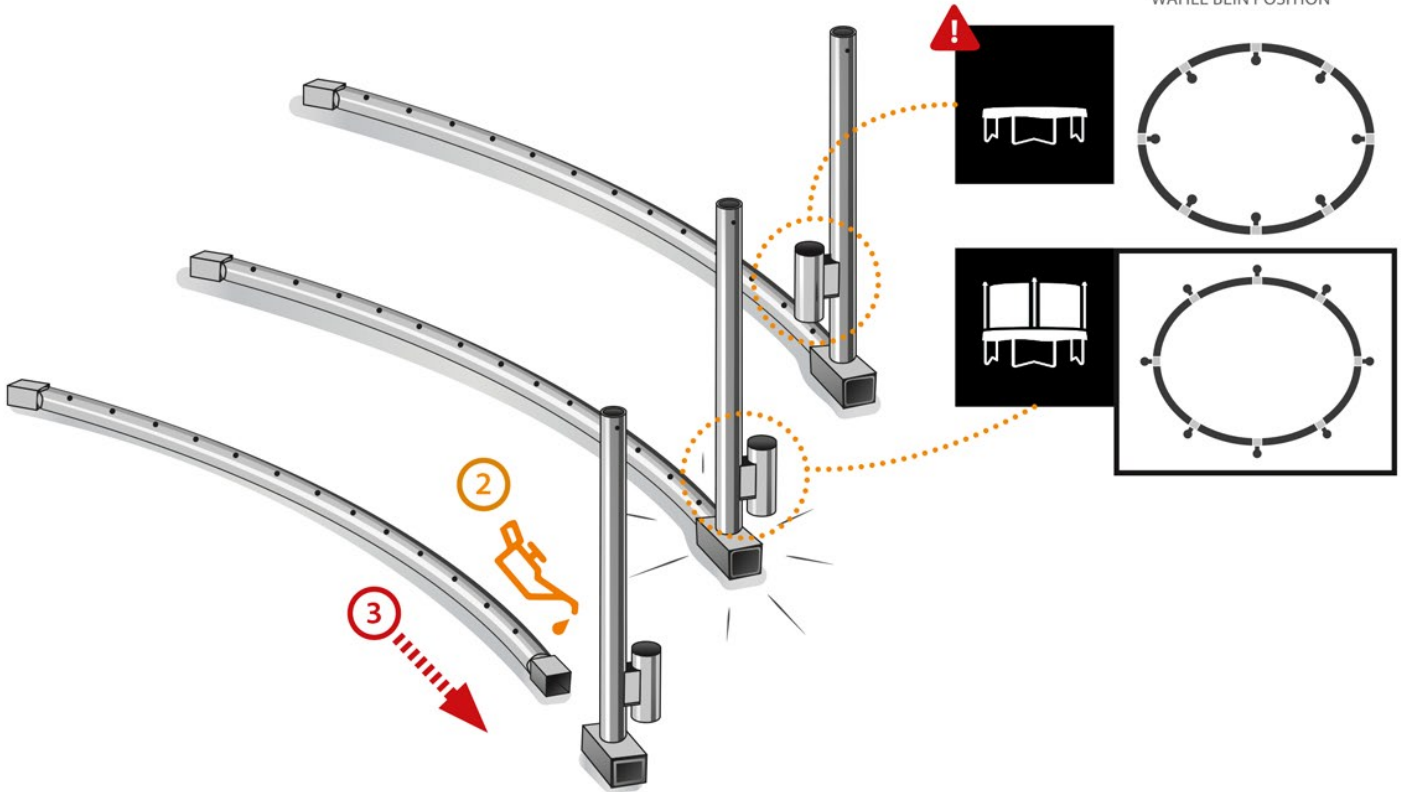

X8



2

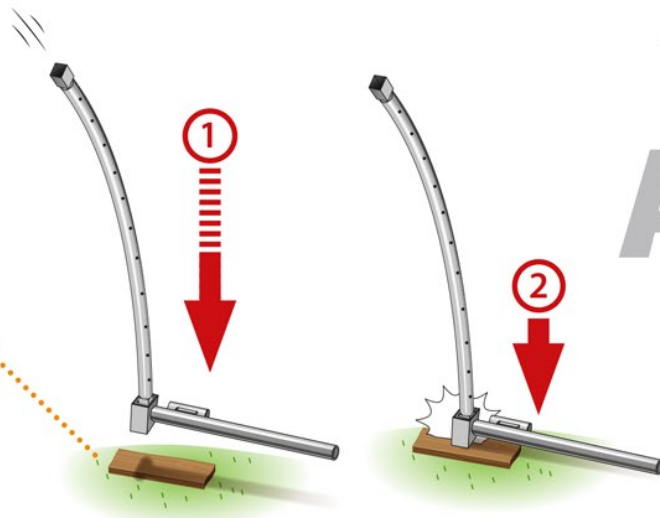
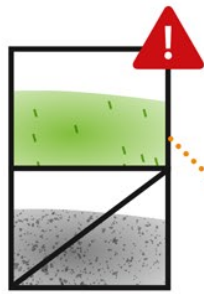

ALL

3

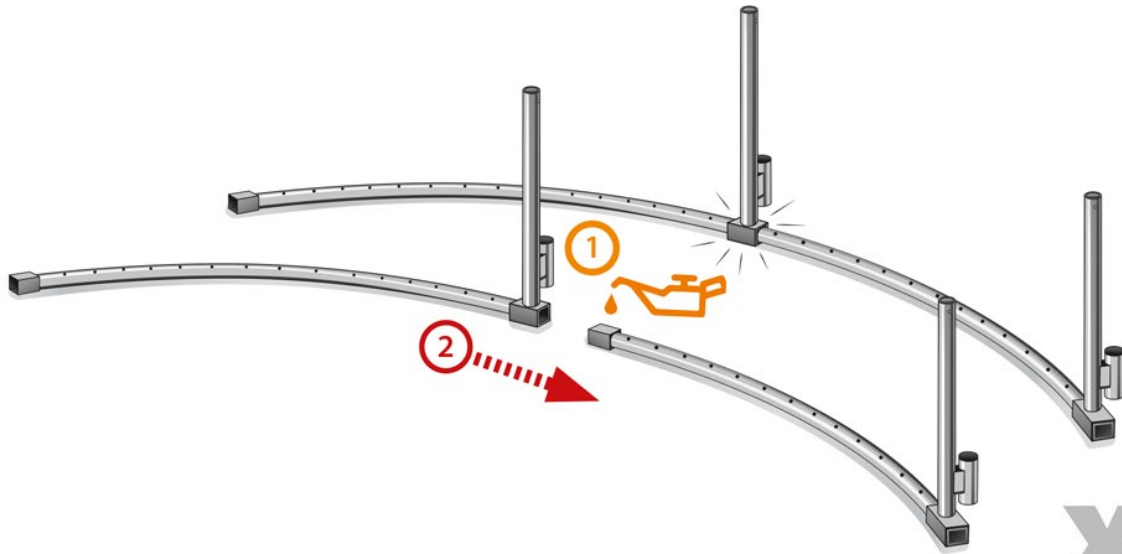

x4

4

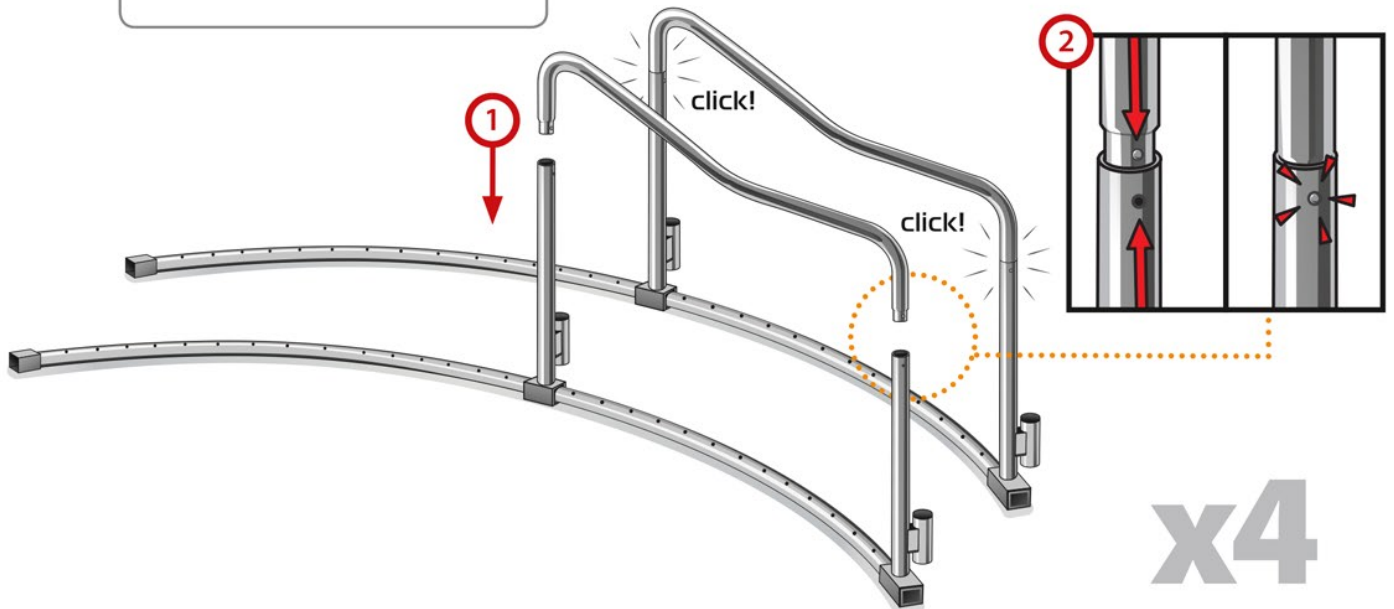
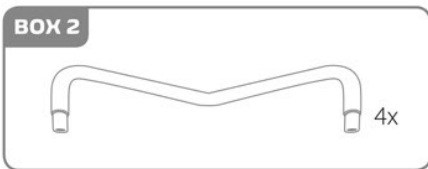

x4



5

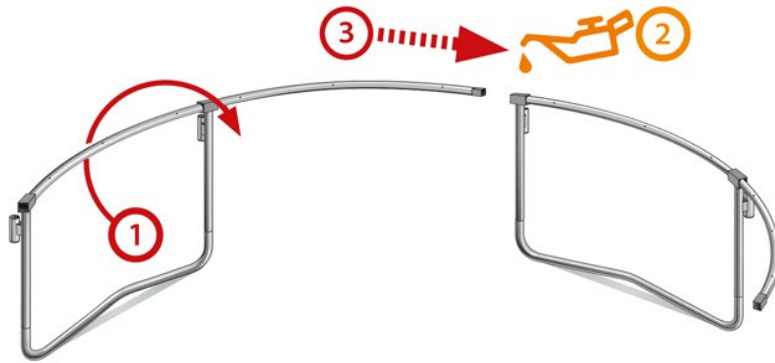

6

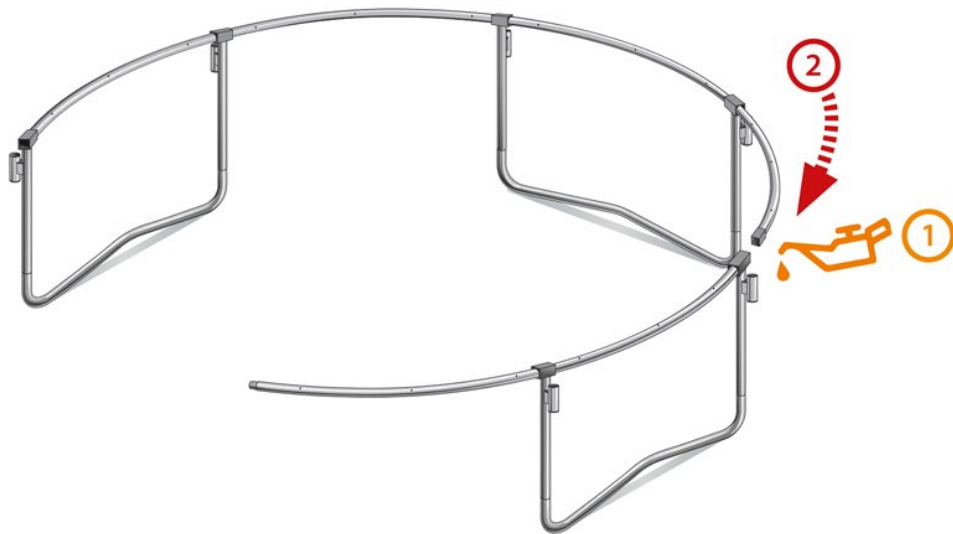

7

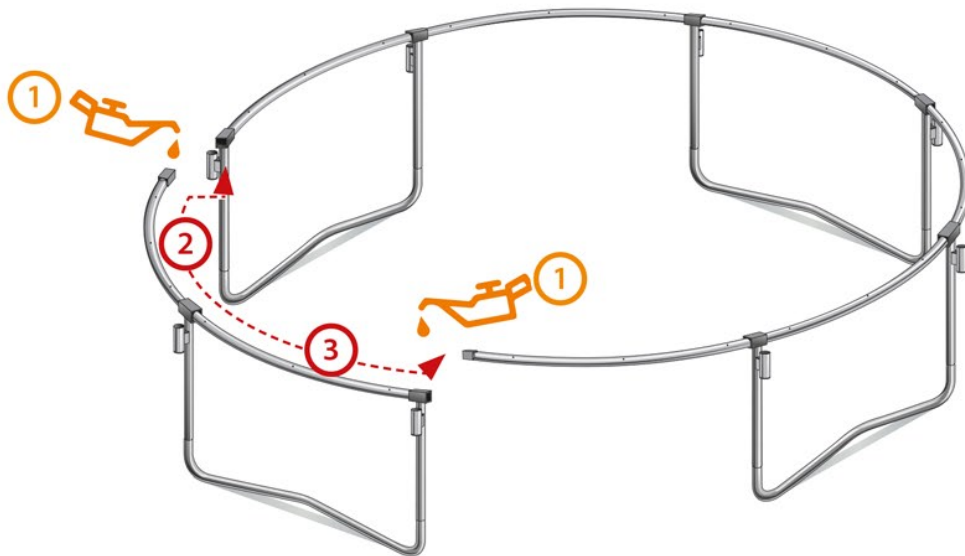

8

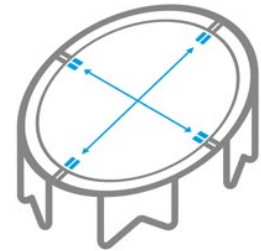
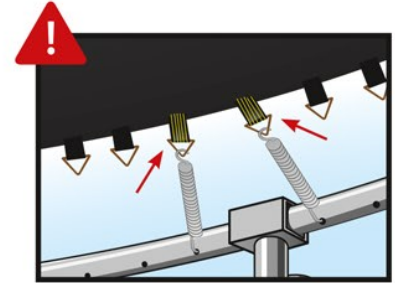
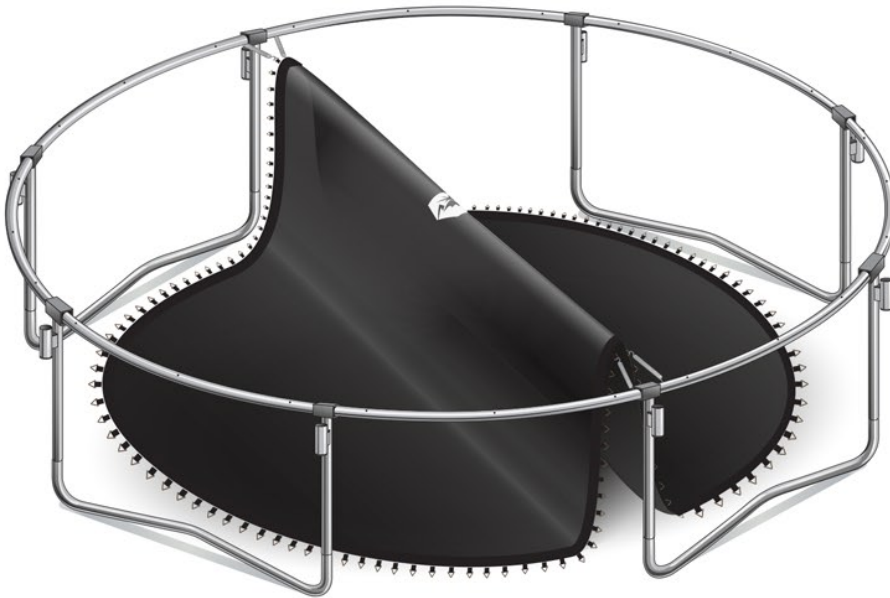
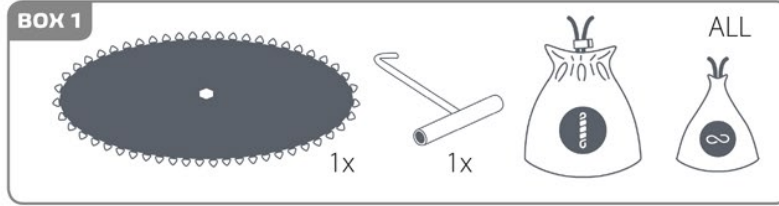

- CHOOSE BOUNCE -
WÄHLE FEDERUNG



* RECOMMENDED FOR
KIDS 3 - 7 YEARS.

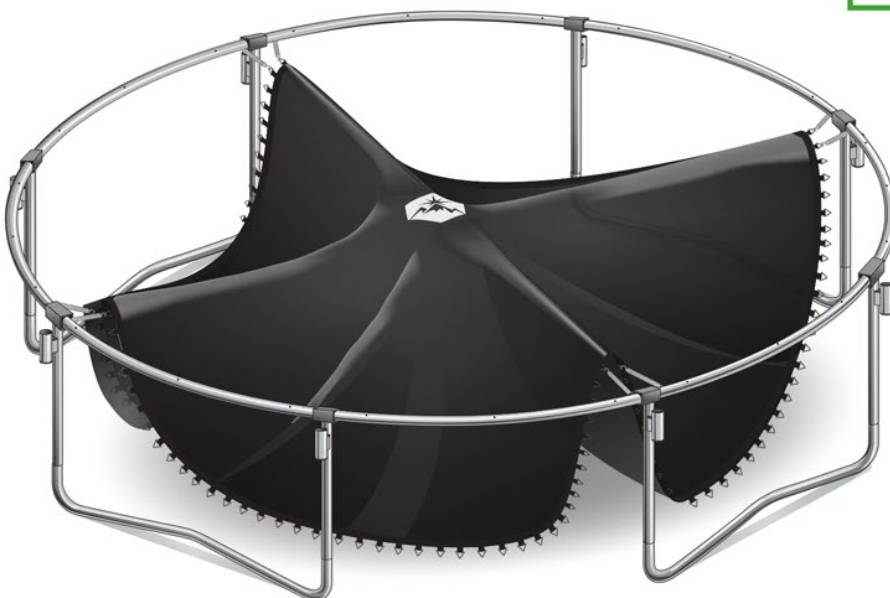

- ATTACH BENEATH TOP RAIL -
ANZUBRINGEN UNTERM TOP RAIL

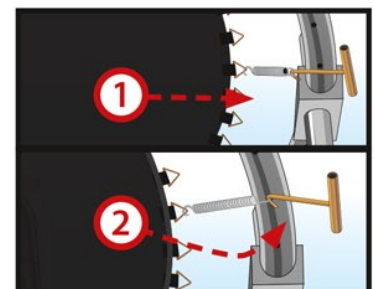

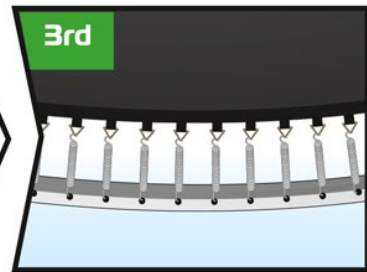
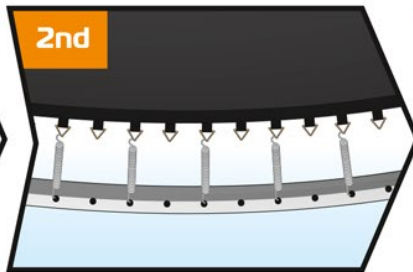
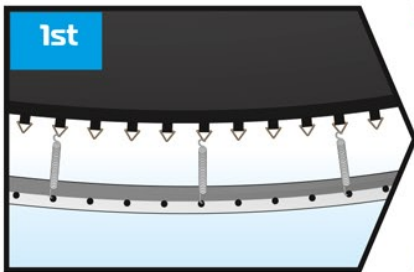

?

continue to page 50

FORTSETZUNG AUF SEITE 50

A warning icon consisting of a red square with a white 'X' over a trampoline mat and the letters "SPS". To the right of the square is a red square containing a white question mark. Below the square is a white box containing the text "continue to page 50" and "FORTSETZUNG AUF SEITE 50". To the right of the box is a white icon of a document with a right-pointing arrow.

A

! **ENG:** SPS is an accessory bought separately and does not come with the standard trampoline package.
SV: SPS är ett tillbehör som köps separat och levereras inte med studsattan.
NO: SPS er et tilbehør og kjøpes separat. Det er ikke inkludert i trampolinens standardpakke.
DK: SPS er et tilbehør og købes separat. Det medfølger ikke trampolinen.
FI: SPS on lisävaruste, joka on hankittava erikseen. Se ei sisälly trampoliinin peruspakettiin.
DE: SPS-SYSTEM ist ein gesondert zu erwerbendes Zubehör und ist nicht im normalen Lieferumfang des Trampolins enthalten.

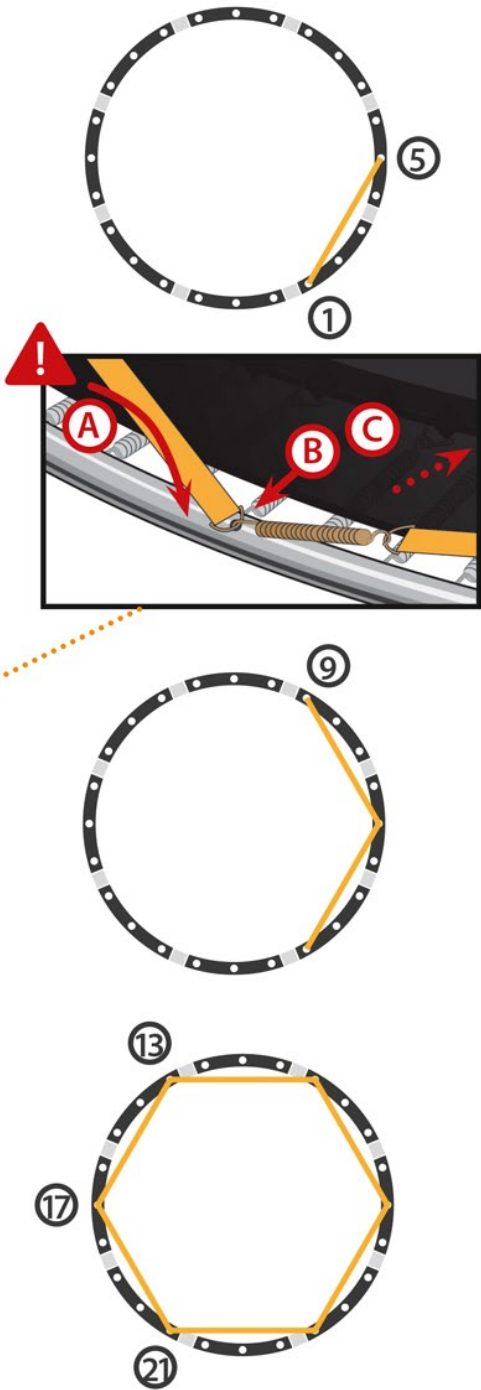
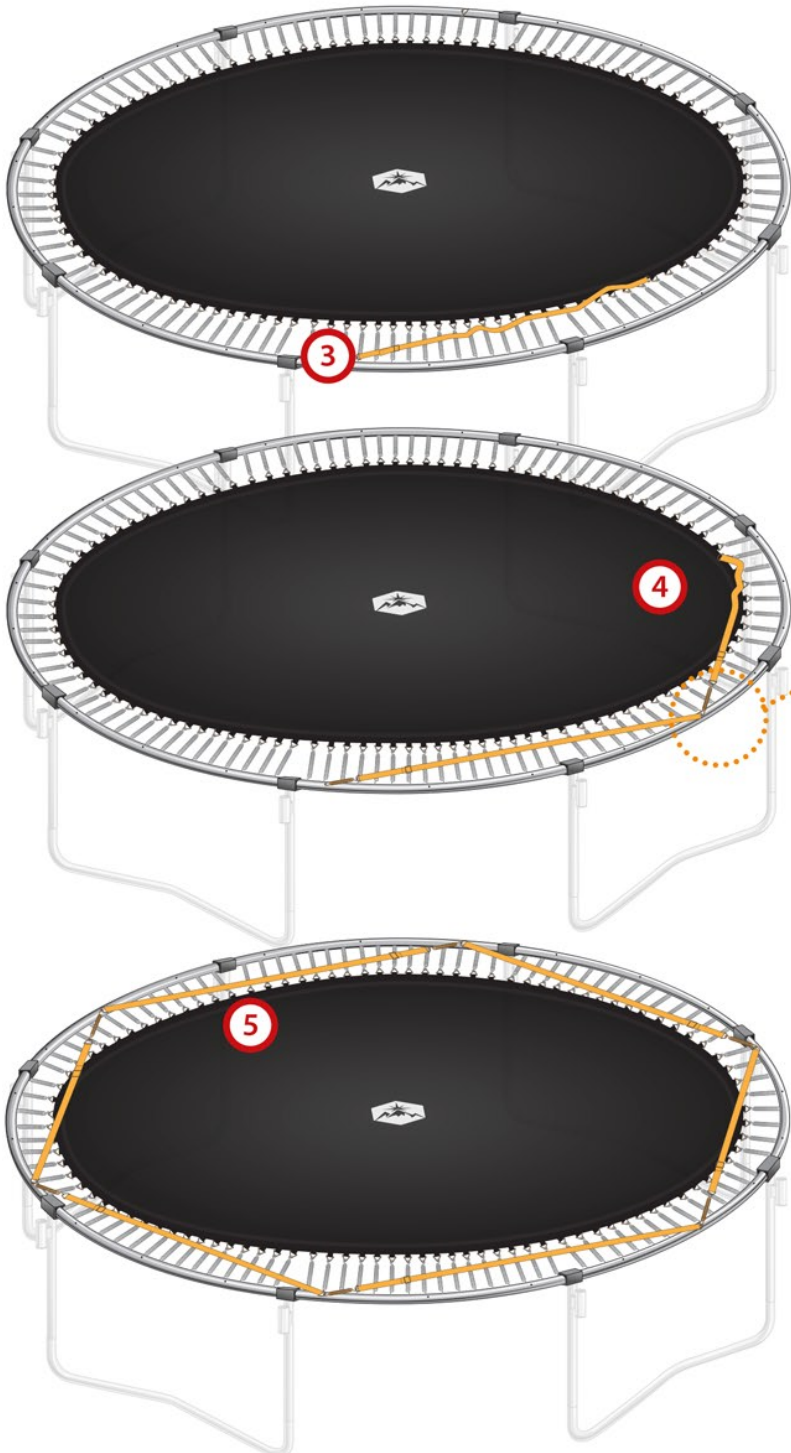
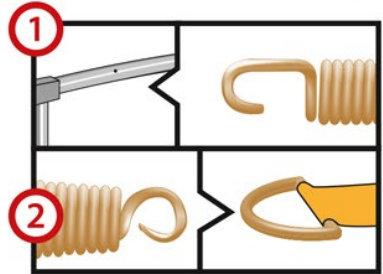
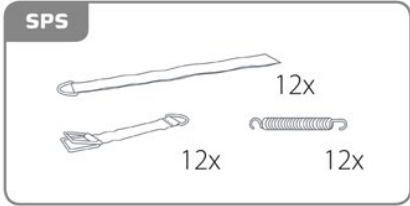

B

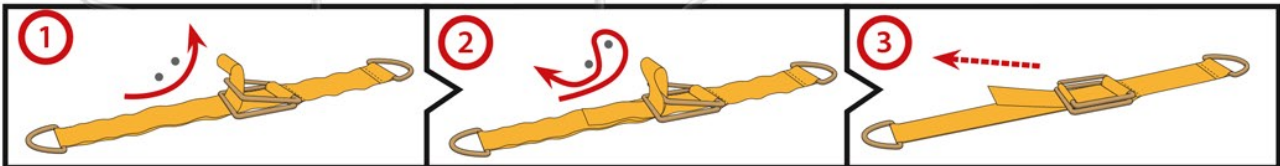
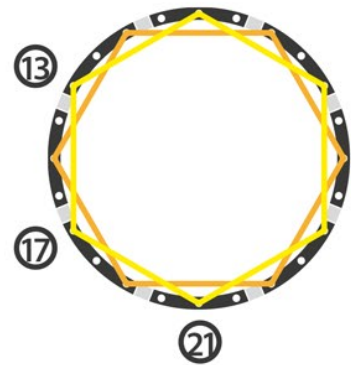
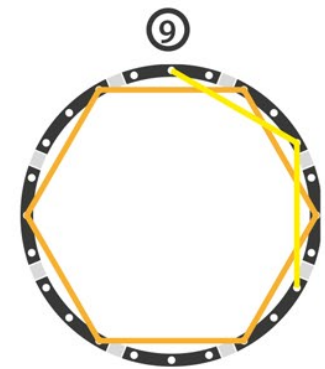
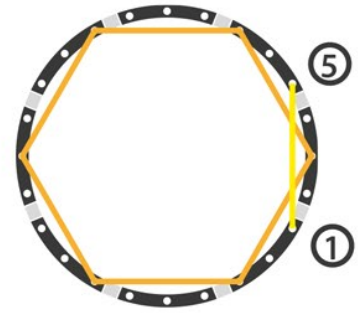
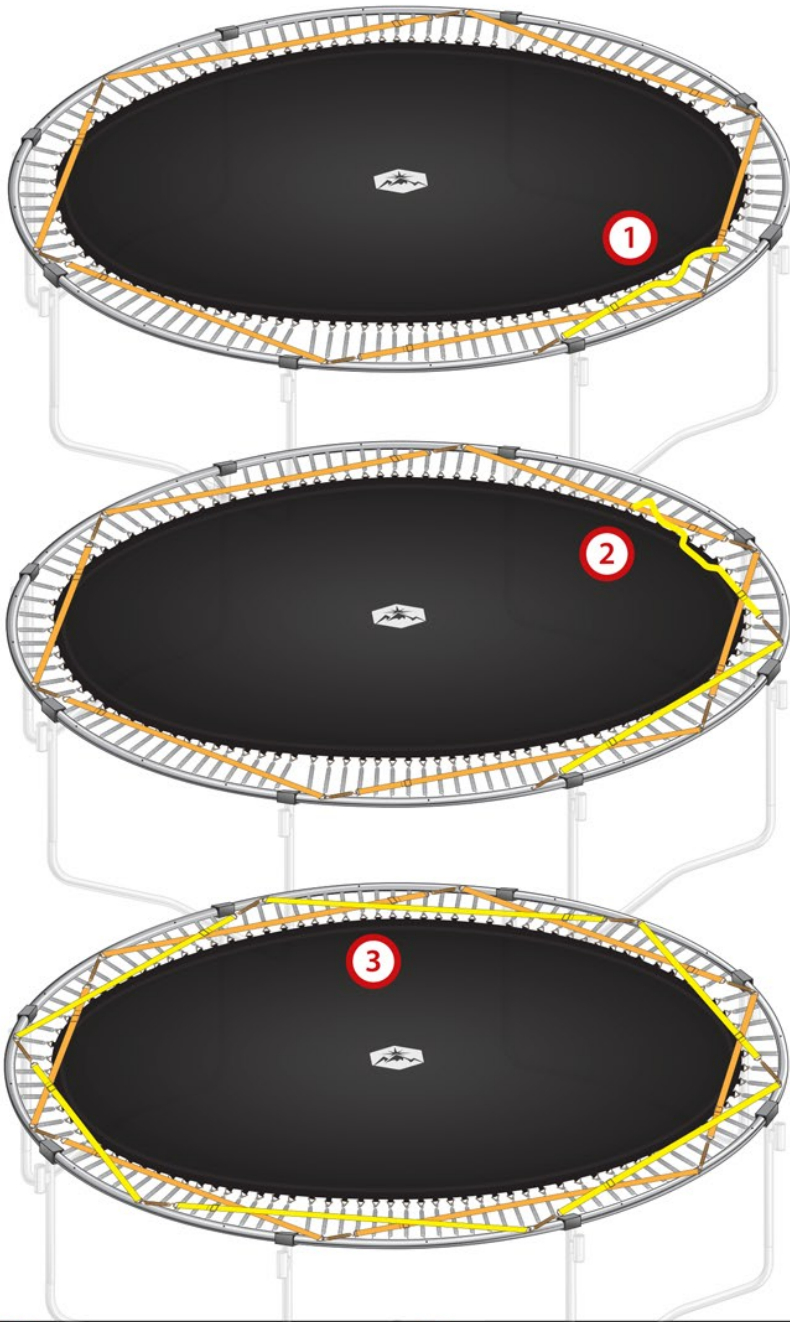

x12

END OF SPS !



10

x8

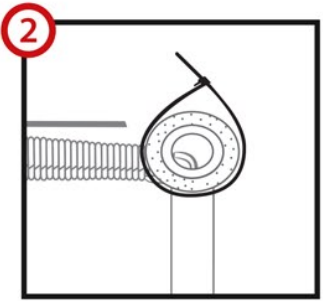
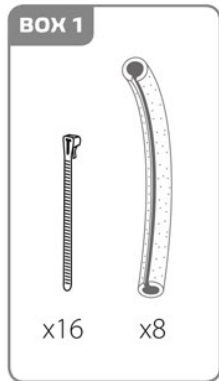

x16

11

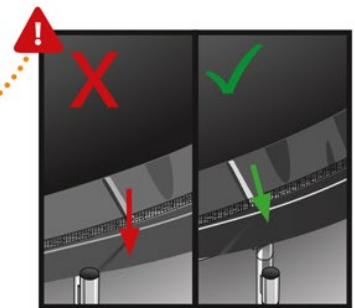
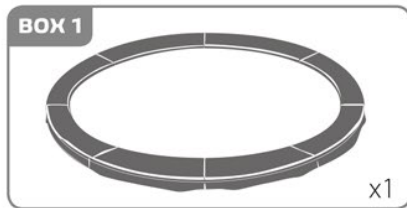

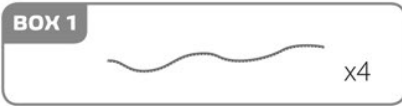

12

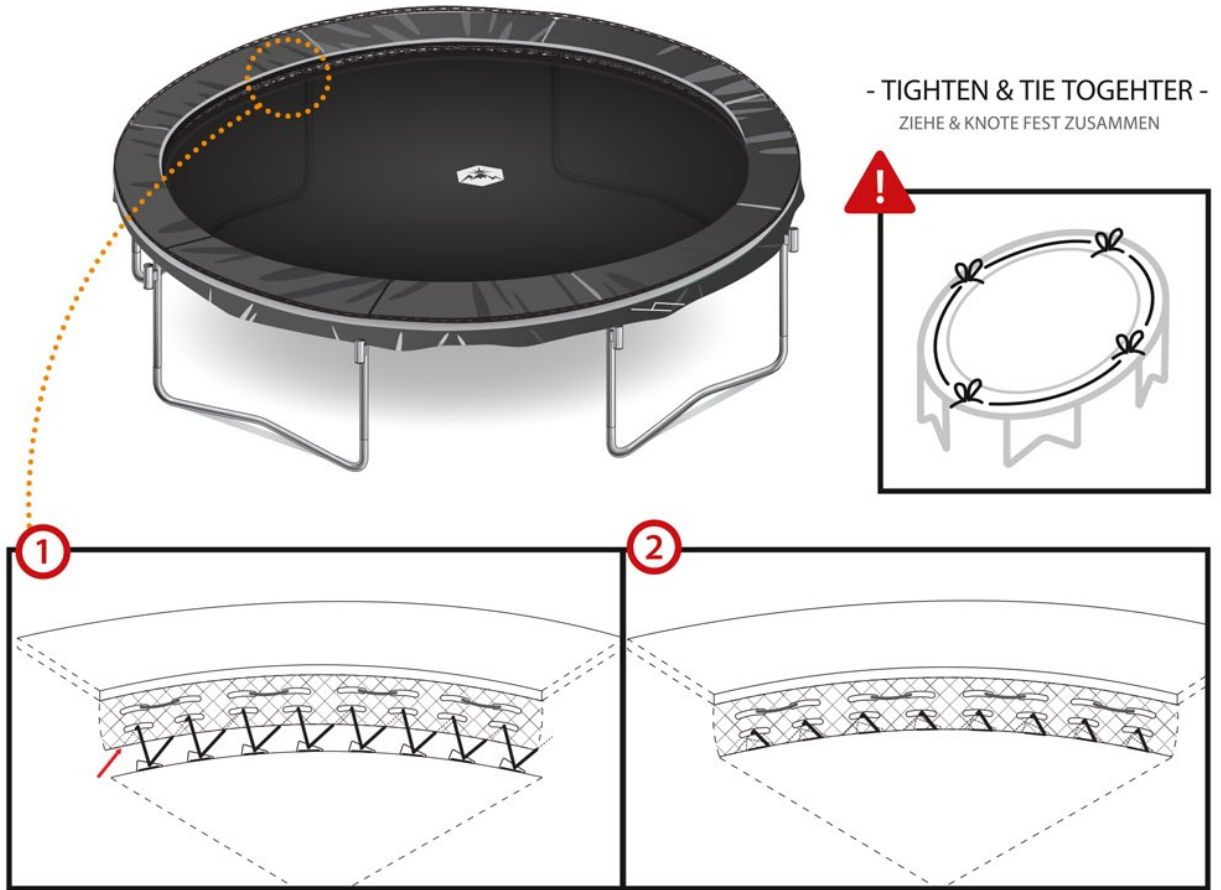

13

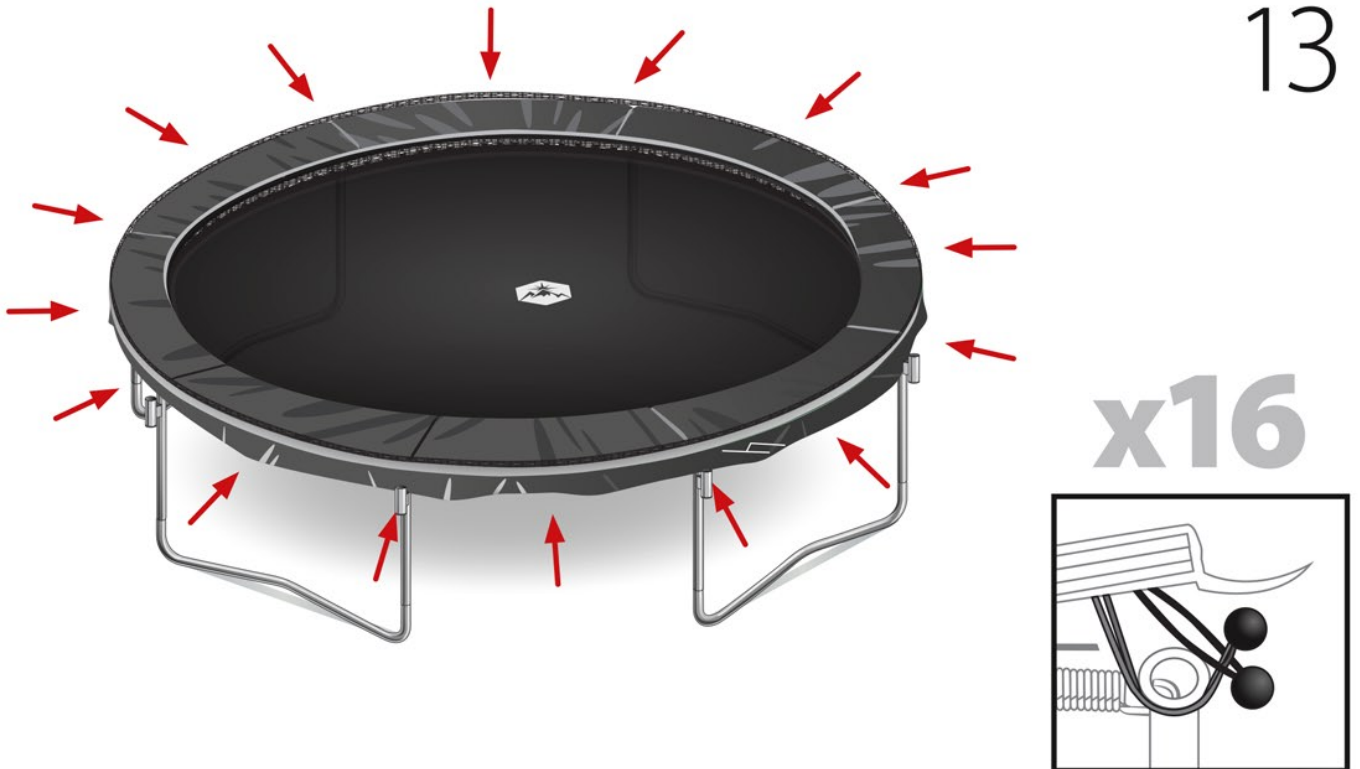

14

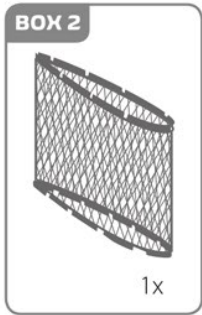

15



- HALF OF ALL PIECES -
DIE HÄLFTE ALLER TEILE

x2

16



1st set
2nd set

x2

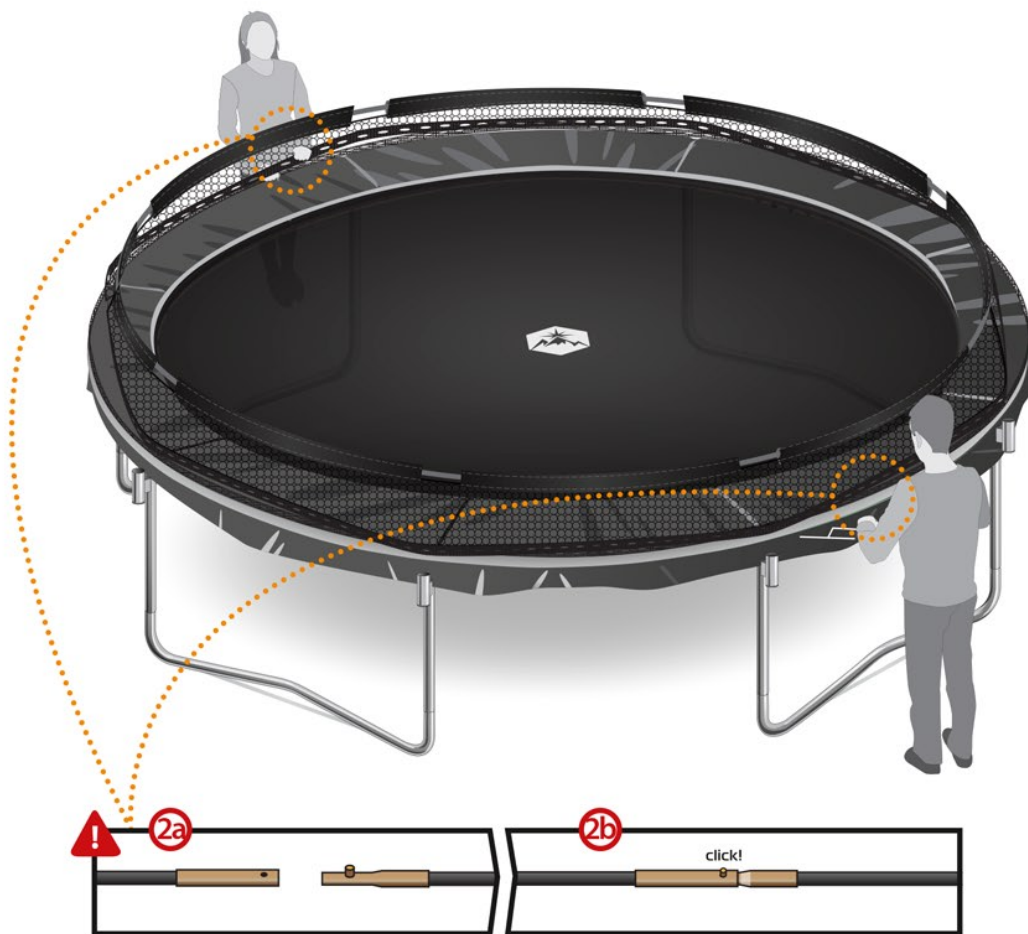

18

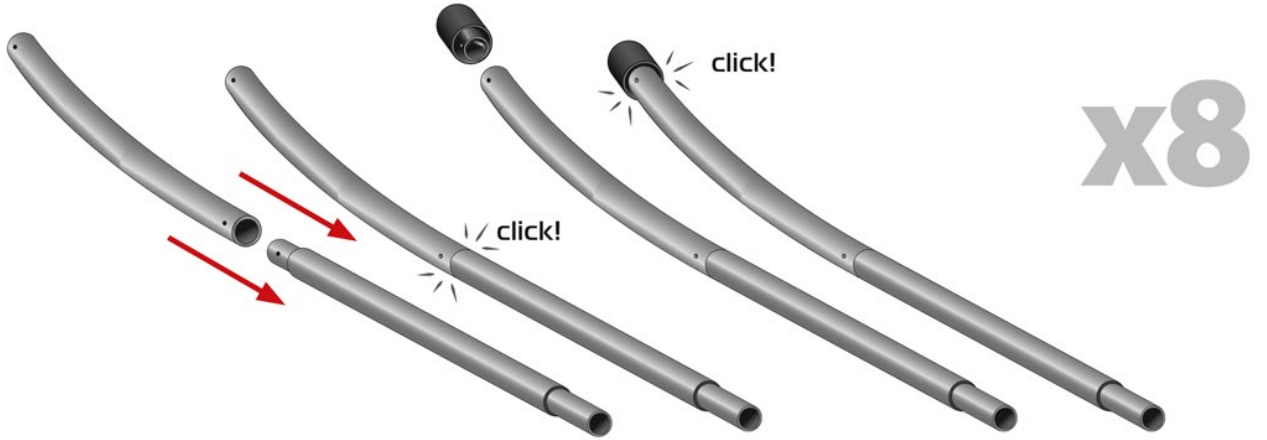
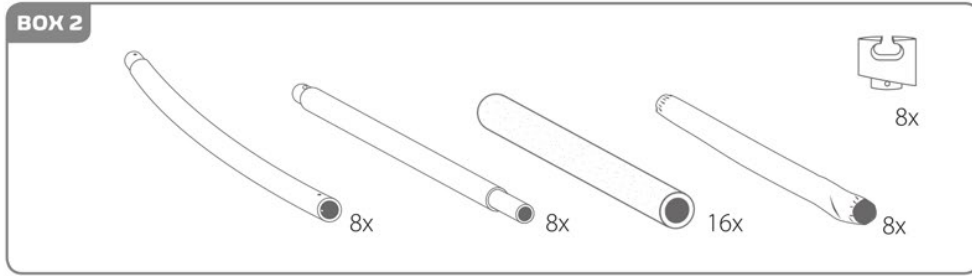

19

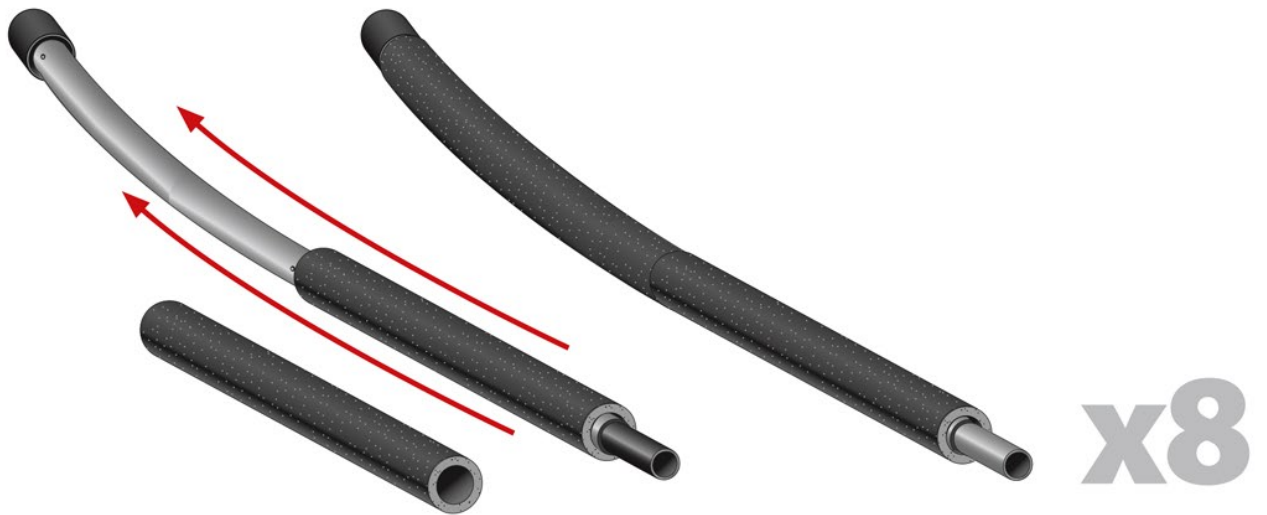

20

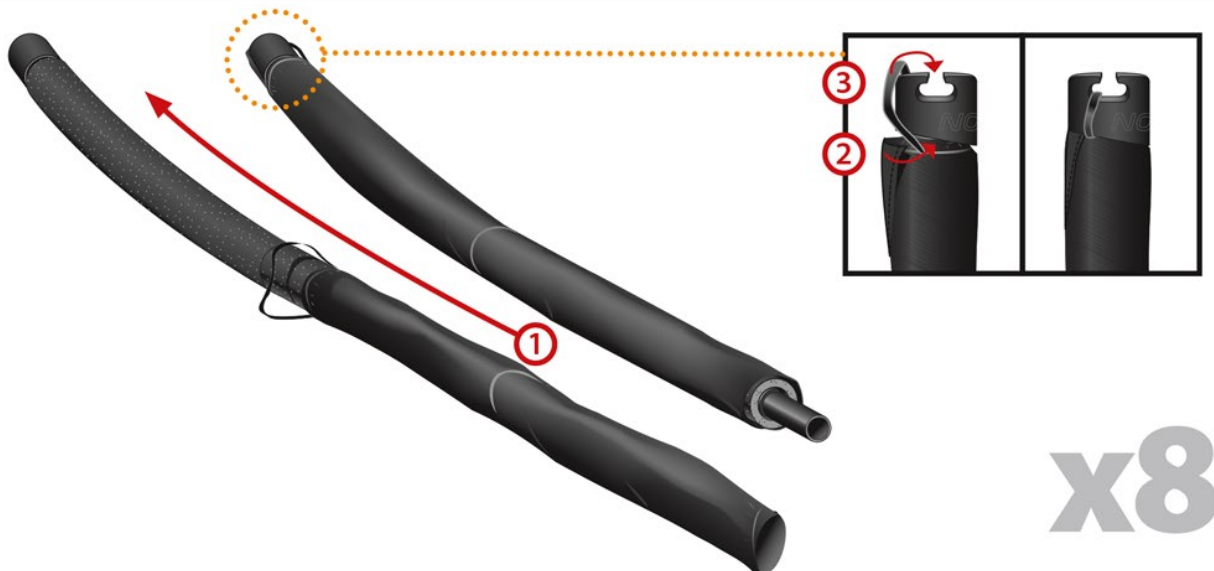

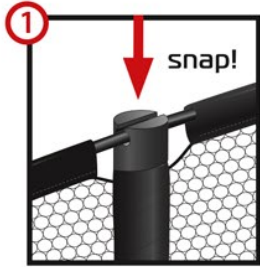

x8

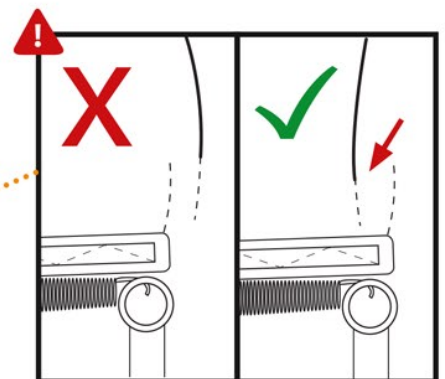
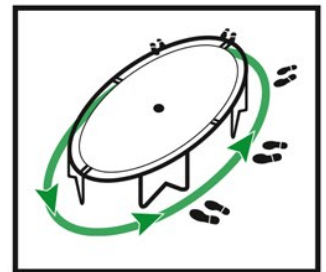

21

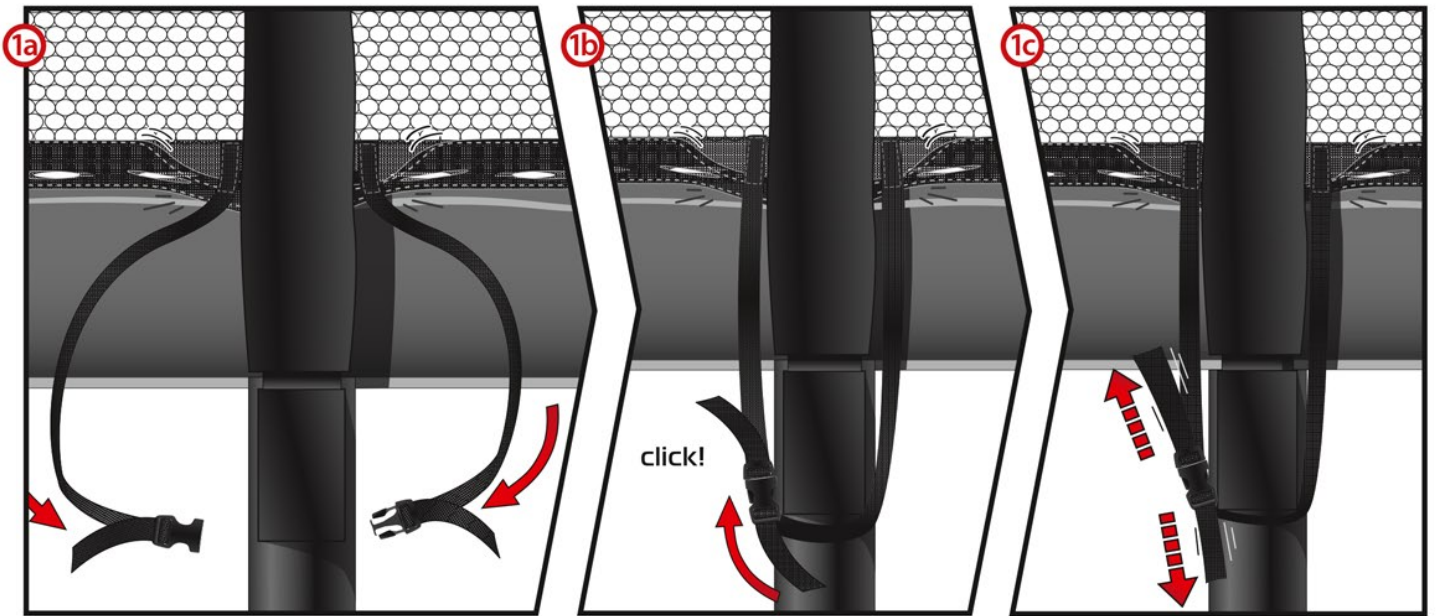

x8

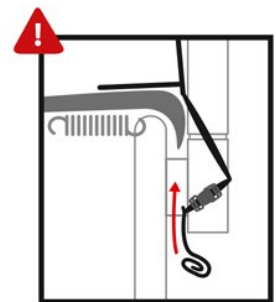

x8



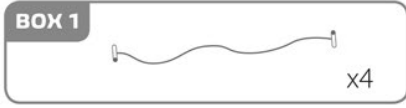

x4

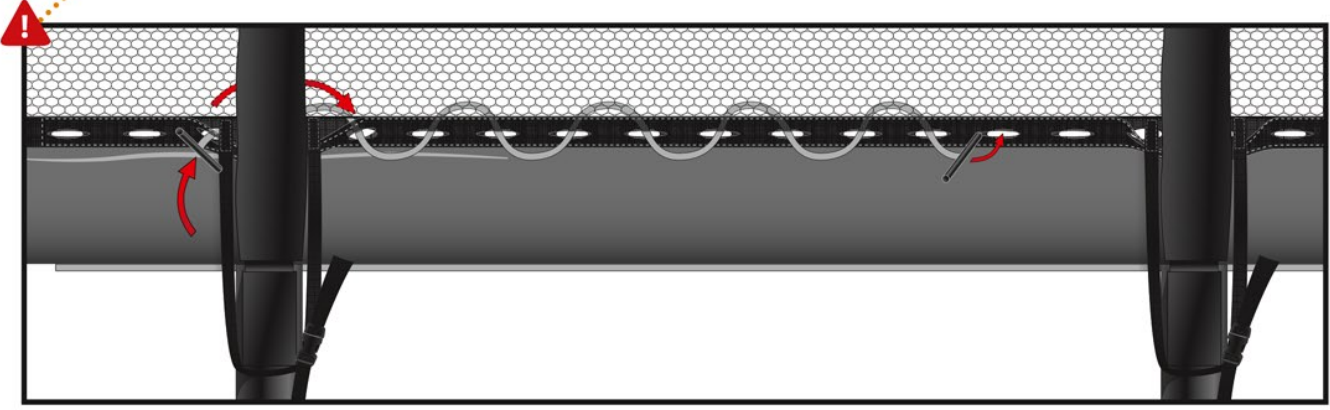
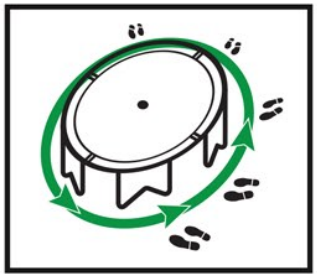

25

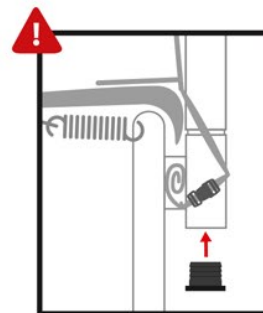
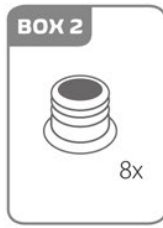

x8

