

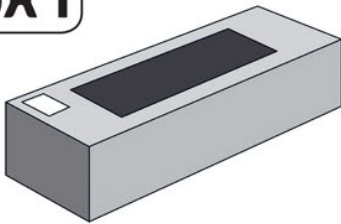

# BOX CONTENT

## BOX 1



**SAFETY NET 1X**  
SICHERHEITSNETZ 1X

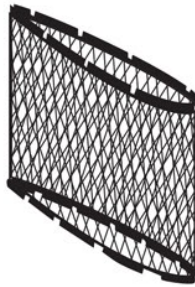

**SPRING TOOL 1X**  
FEDERMONTAGEWERKZEUG 1X



**FRAME PADDING 2X**  
RAHMENPOLSTERUNG 2X

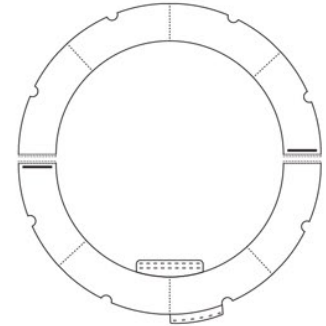

**SPRINGS 72/88X**  
FEDERN 72/88X



**TOP RAIL 8X**  
OBERRAHMEN 8X

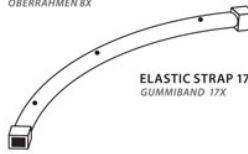

**ELASTIC STRAP 1X**  
GUMMIBAND 1X



**JUMP MAT 1X**  
SPRUNGMATTE 1X



**ELASTIC STRAP 17X**  
GUMMIBAND 17X



**SPRING GUARD STRAP 2X**  
FEDERSCHUTZBÄNDER 2X



## BOX 2

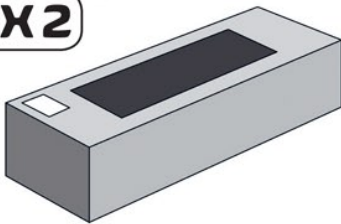

**SAFETY NET POLES 16X**  
SICHERHEITSNETZPFOSTEN 16X



**STEEL RIM 8X**  
STAHLUMRANDUNG 8X



**POLE FOAM 16X**  
SCHAUMSTOFFPOLSTER FÜR SICHERHEITSNETZPFOSTEN 16X

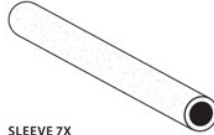

**MIDDLE POST 8X**  
MITTELPFOSTEN 8X



**SCREW FOR TOP CAP 8X**  
ABSCHLUSSKAPPENSCHRAUBE 8X



**SLEEVE 7X**  
SCHUTZHÜLLE 7X

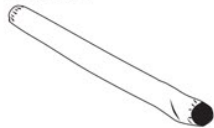

**TOP CAP 8X**  
ABSCHLUSSKAPPE 8X



**TOOL FOR TOP CAP SCREW 1X**  
WERKZEUG FÜR ABSCHLUSSKAPPENSCHRAUBE 1X



**LEGS 4X**  
BEINE 4X



# ASSEMBLY INSTRUCTIONS

## MONTAGEANLEITUNG

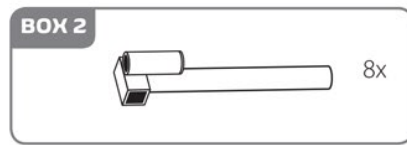
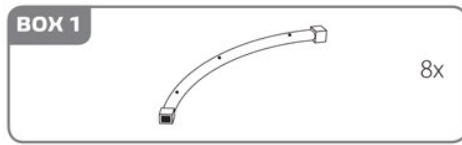

1

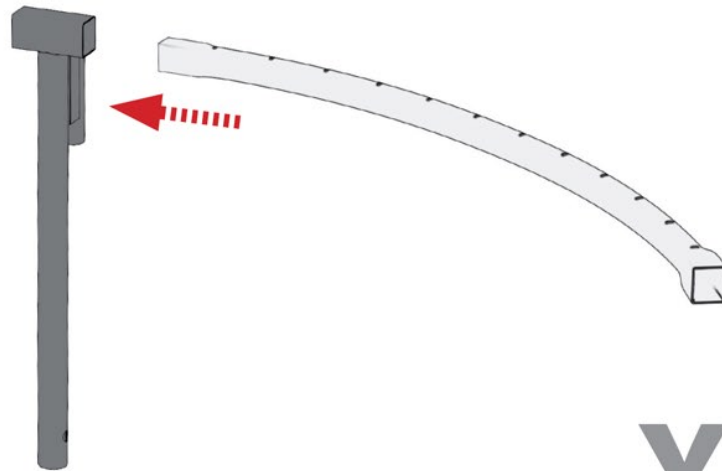

**X8**

2

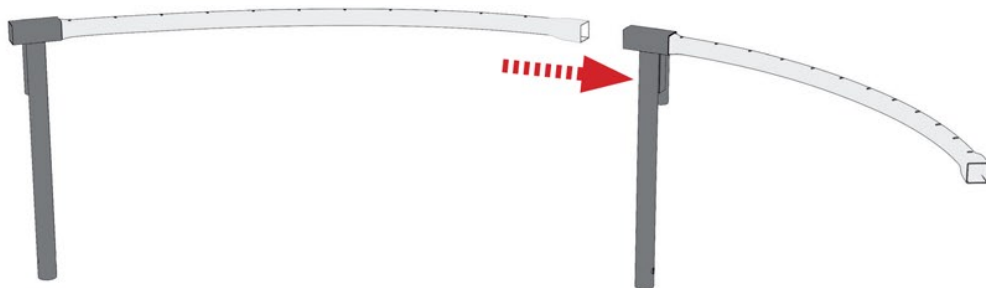

**X4**



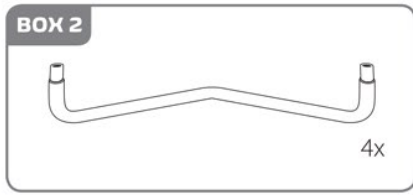

3

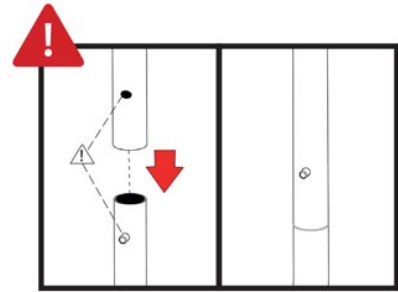
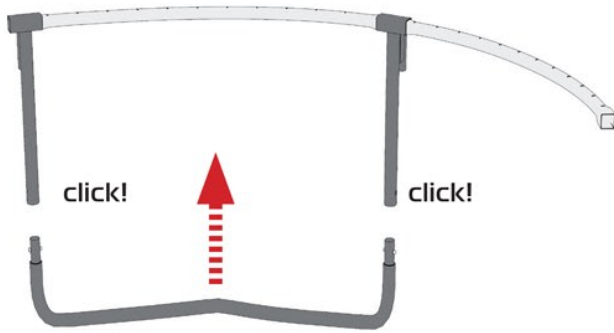

ALL

4

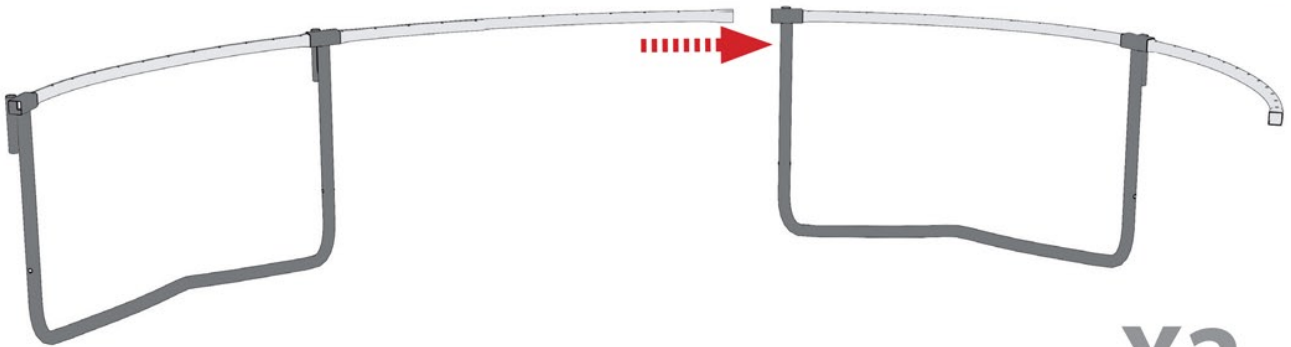

X2

5

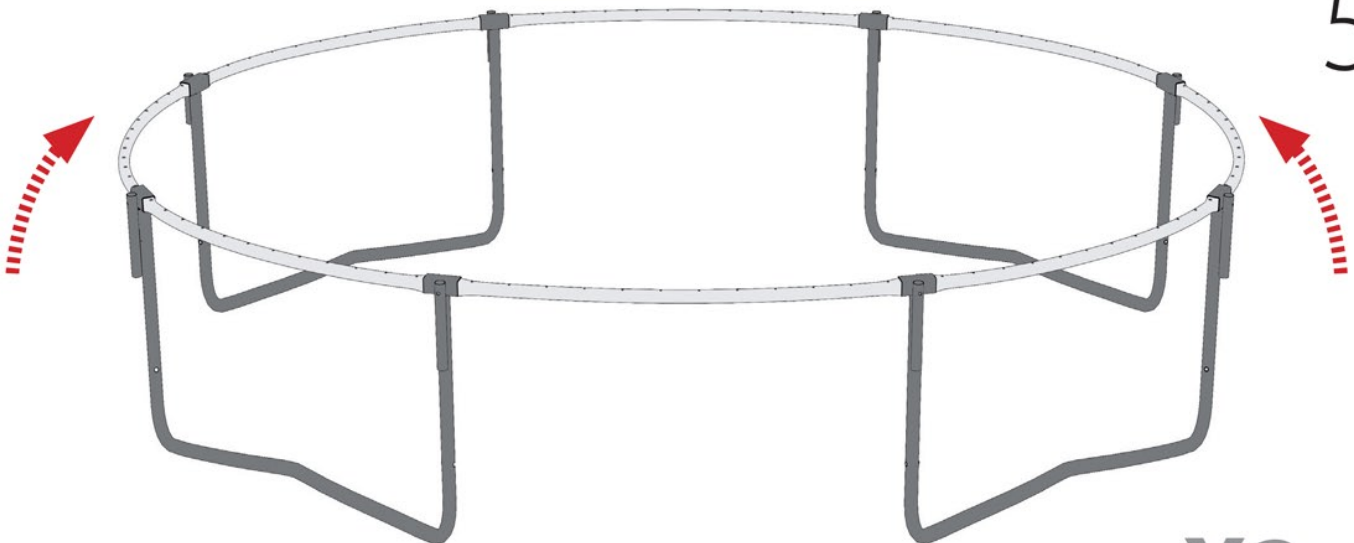

X2



6



**- ATTENTION -**  
ONLY ATTACH 4x SPRINGS,  
NOT ALL DUE TO STEPS  
12-13.

**- ACHTUNG -**  
NUR 4 x FEDERN ANBRIN-  
GEN, NICHT ALLE AUFGR-  
UND DER SCHRITTE 12-13.

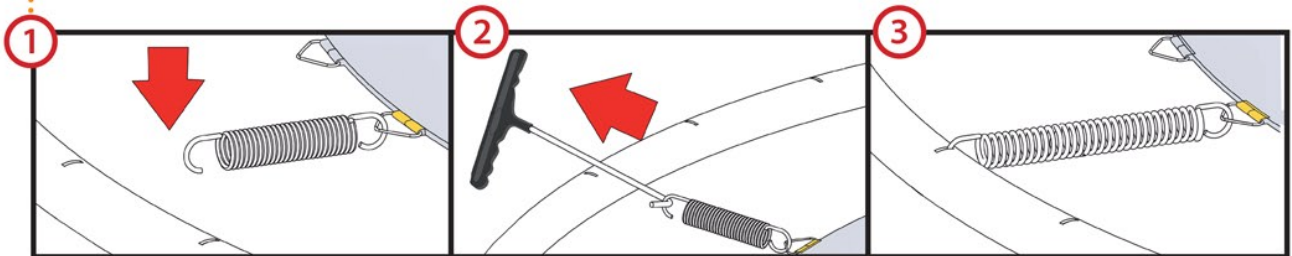
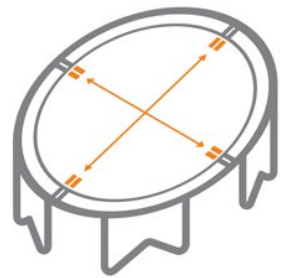
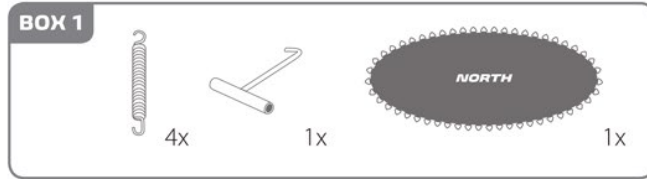

x4



7

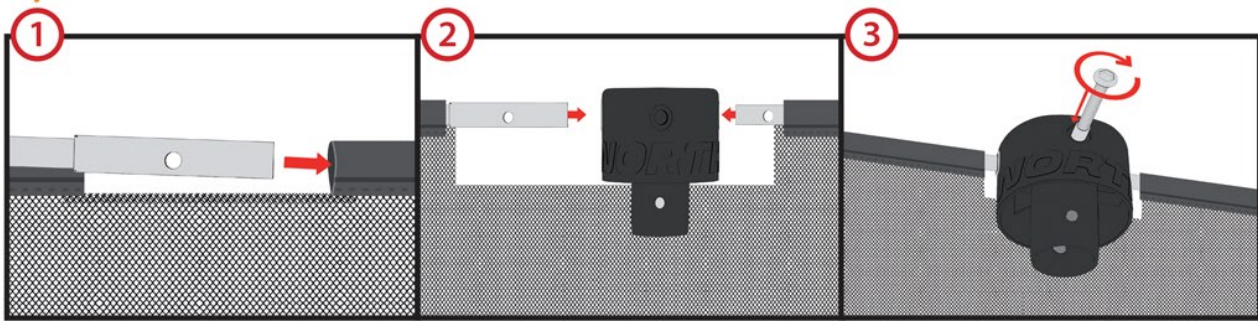
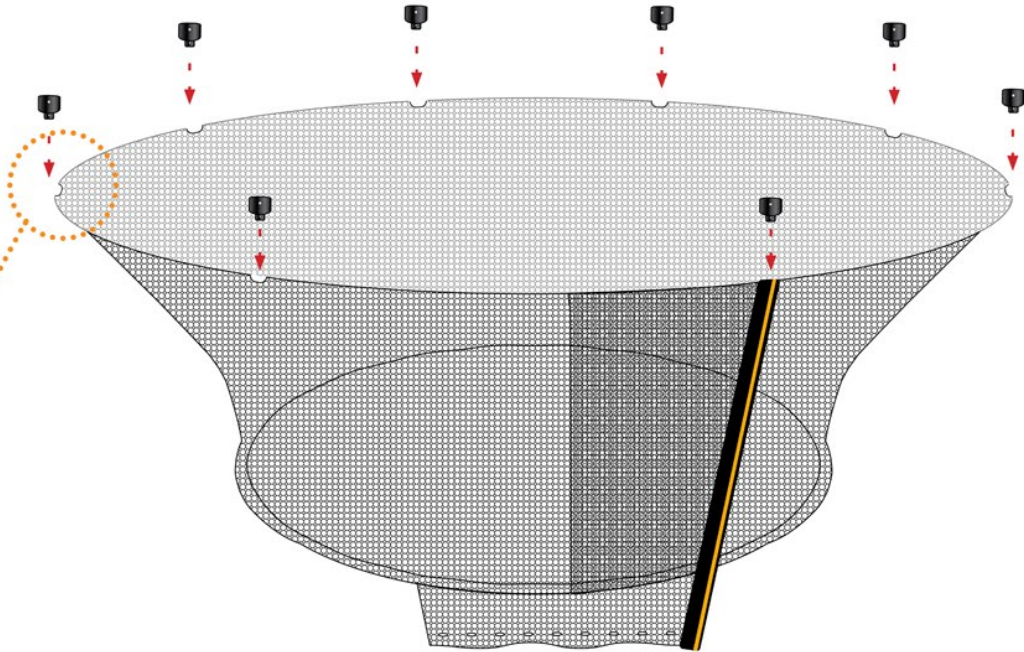
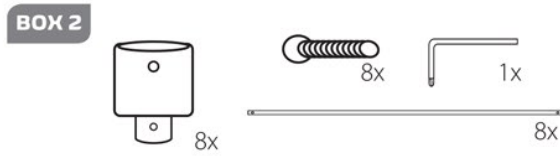
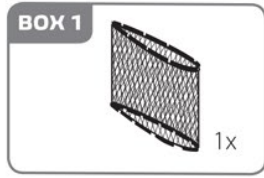

X8

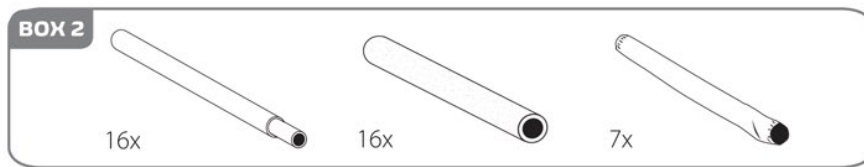

8

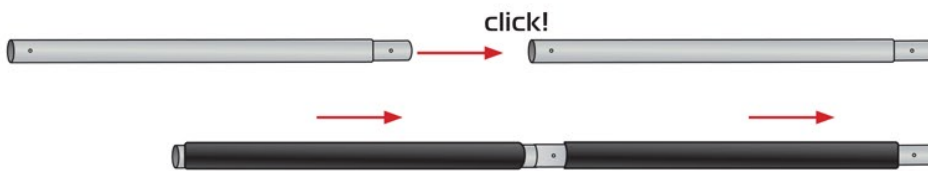

x8



x7

9



# 10A

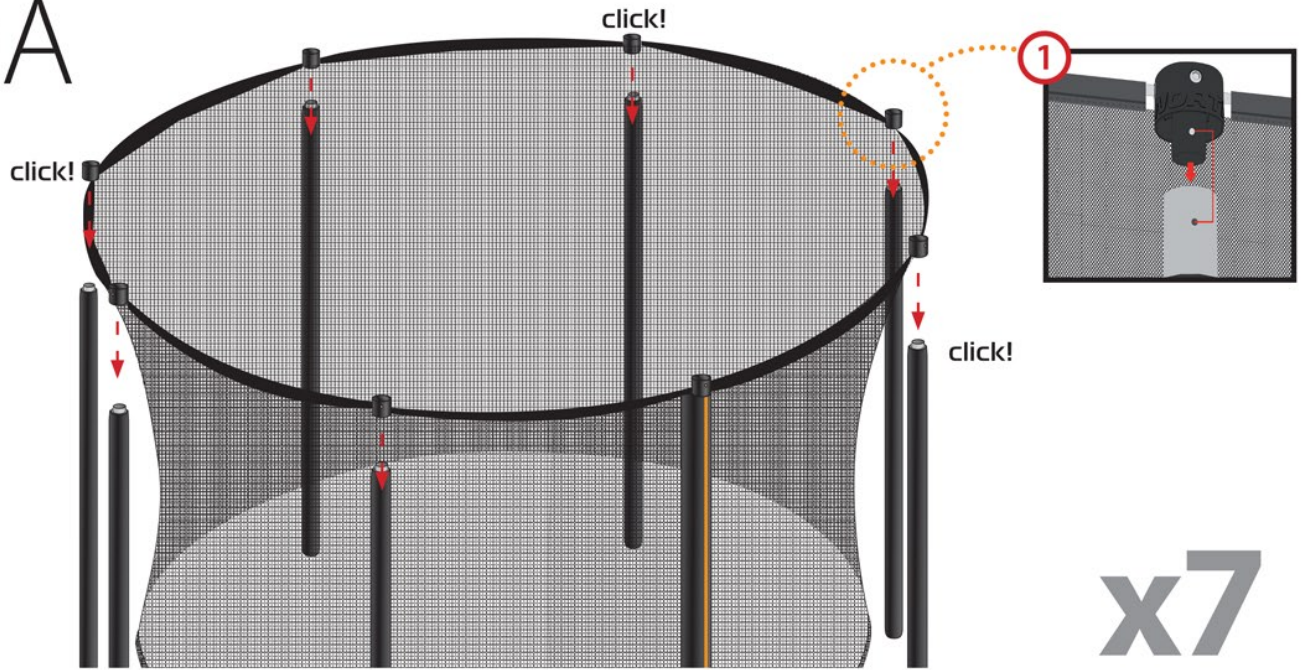

# 10B

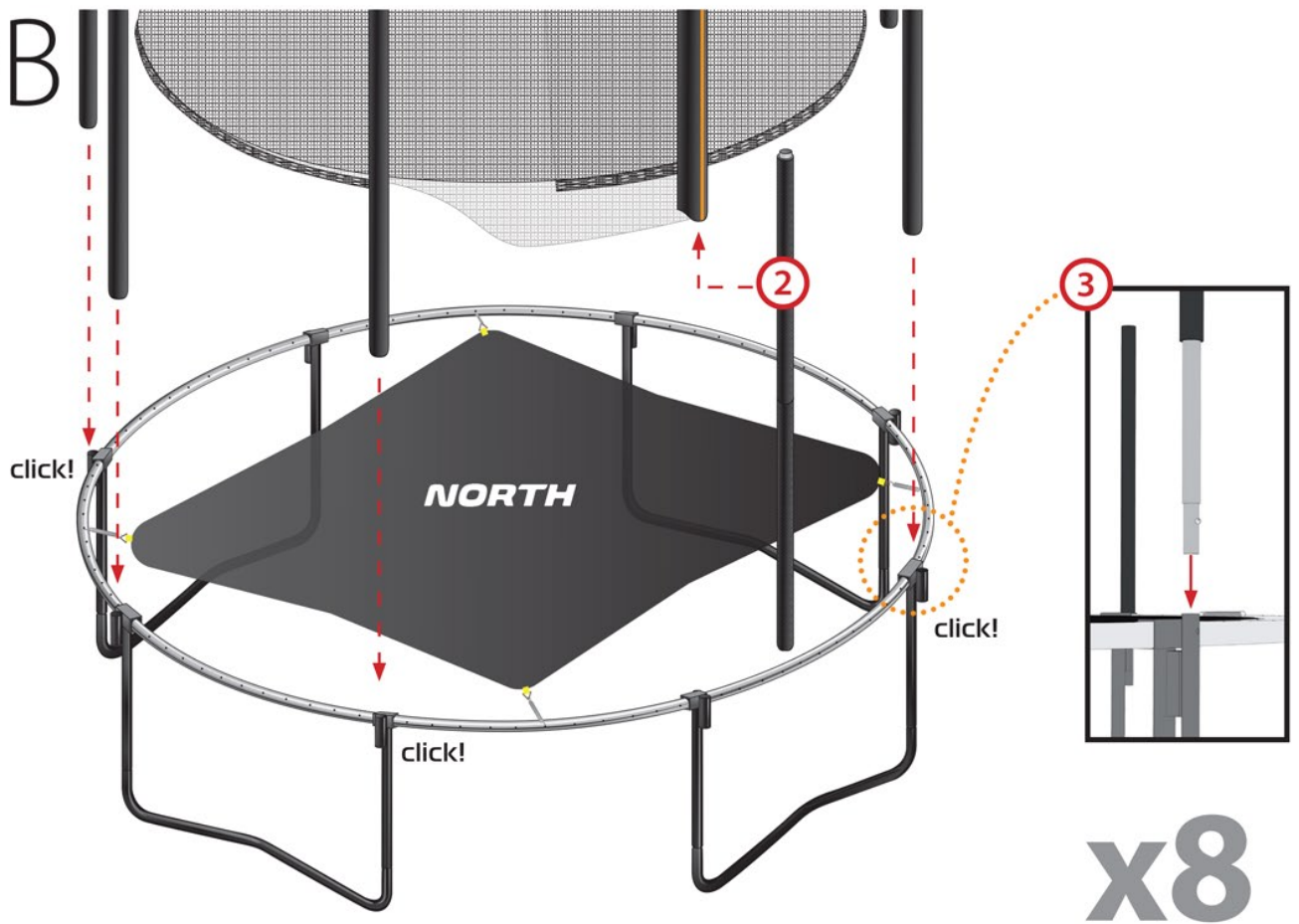

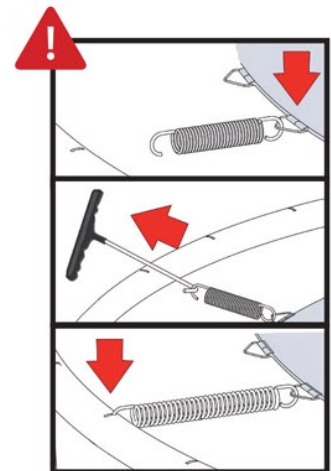
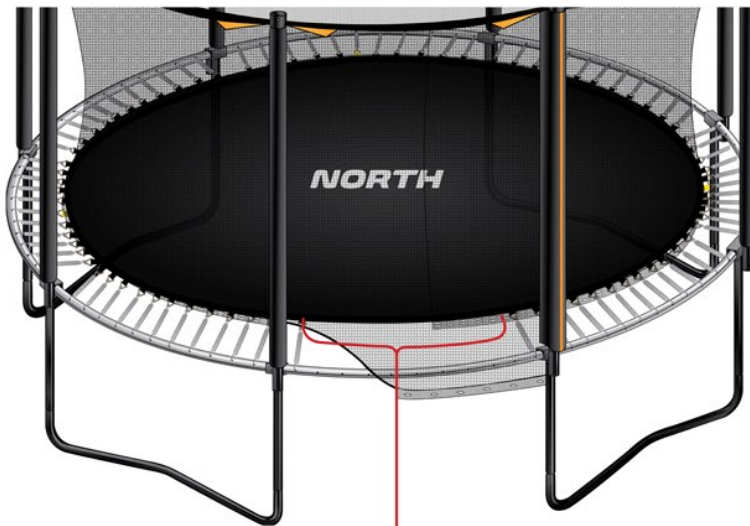
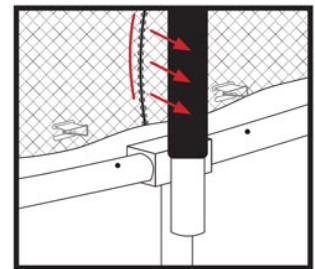
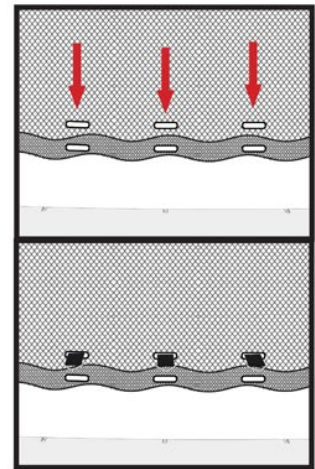

**! - ATTENTION -**  
 \* LEAVE 9 or 11 SPRINGS IN THE ENTRANCE **UNMOUNTED** FOR LATER.

**- ACHTUNG -**  
 \* LASS 9 / 11 FEDERN BEI DER MONTAGE HIER AUS.

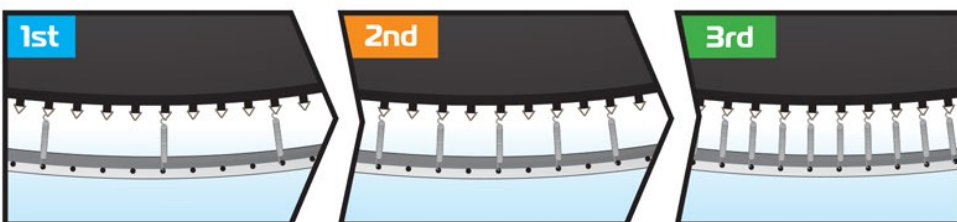



13

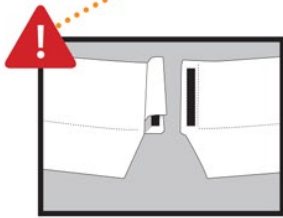
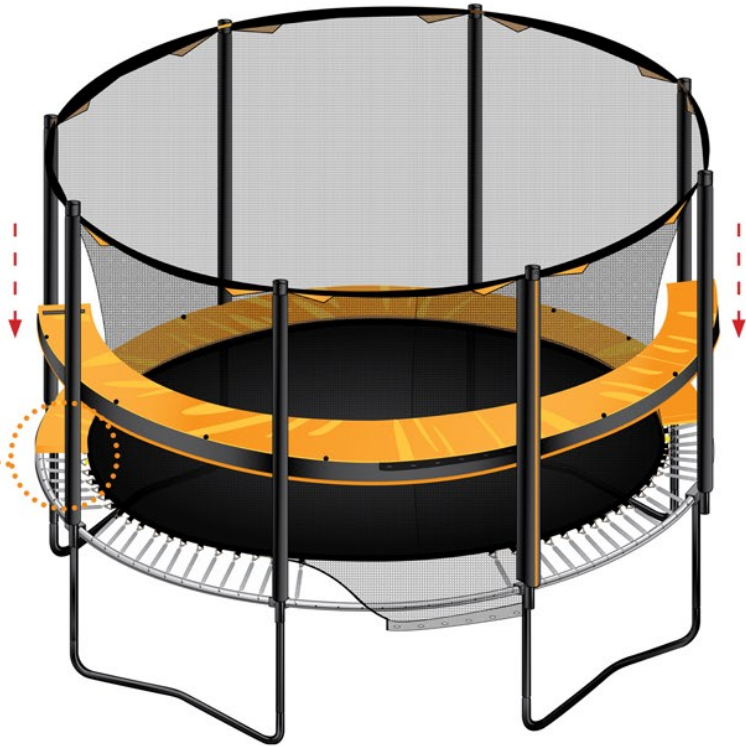
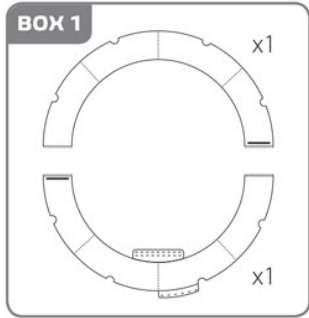

14

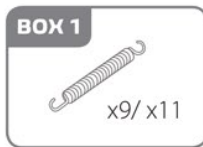

- MOUNT BELOW ENTRANCE PADDING -  
- Montiere unter dem Randpolster -

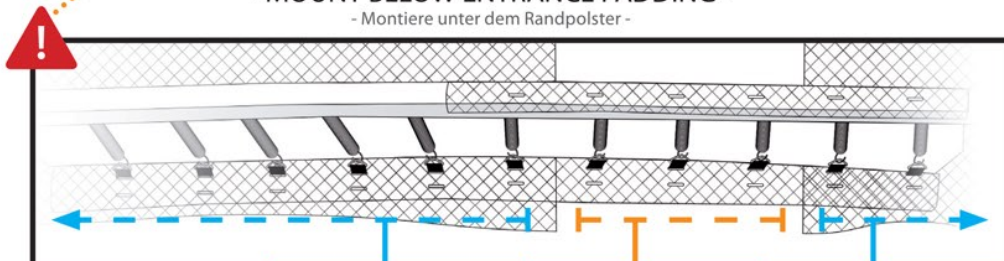

x9/x11

MODELL:	OVERLAP LEFT	ENTRENCE	OVERLAP RIGHT	TOTAL:
PIONEER 430	2 SPRINGS	4 SPRINGS	3 SPRINGS	9 SPRINGS
PIONEER 360	2 SPRINGS	4 SPRINGS	5 SPRINGS	11 SPRINGS

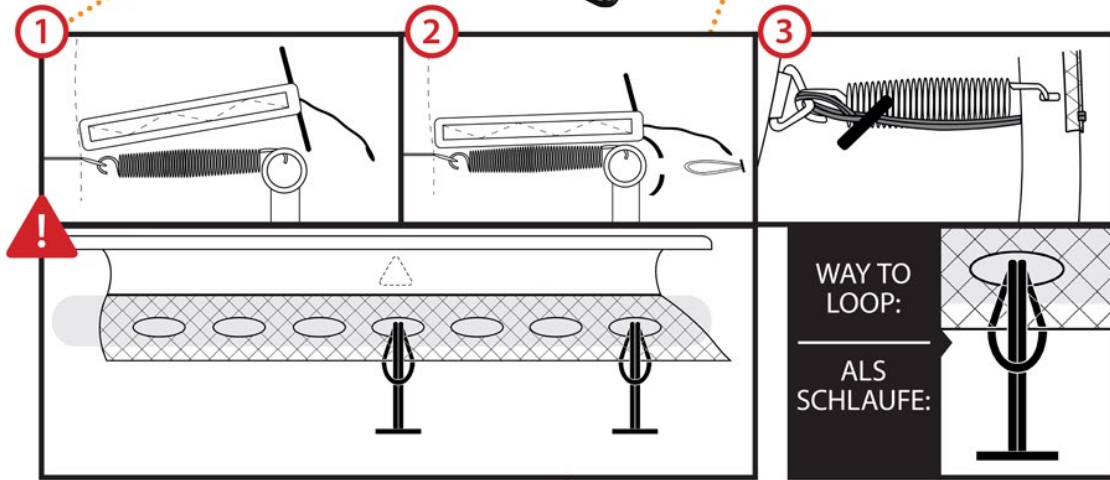
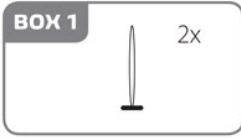

x2

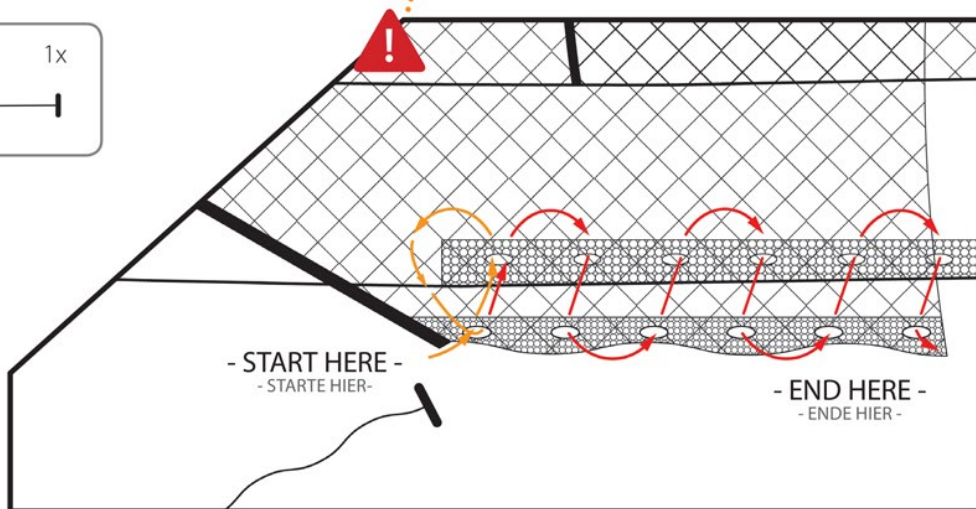

17

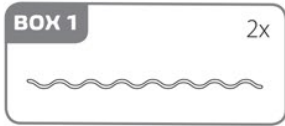

- STRAP ROUTE -  
BANDVERLAUF

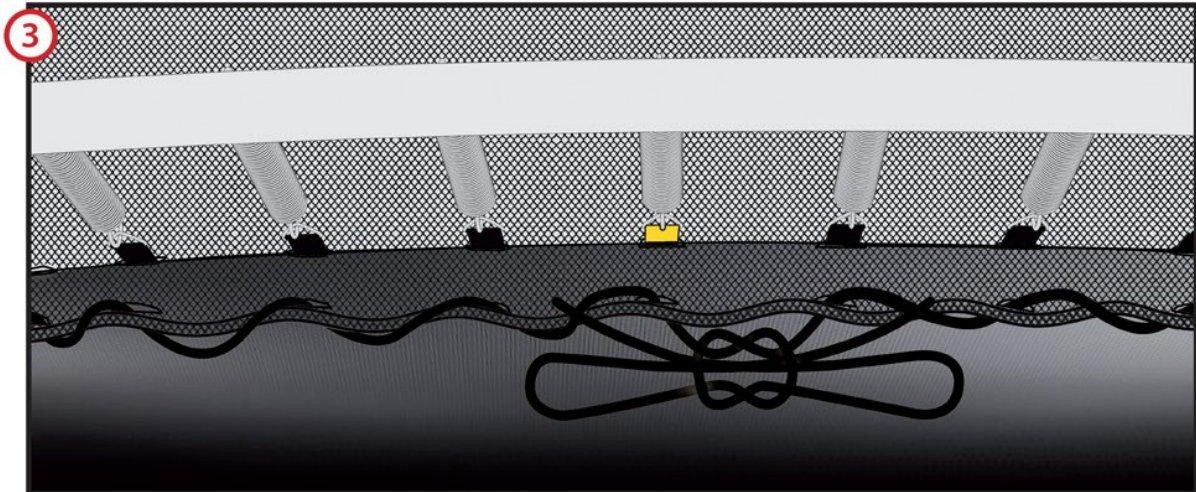
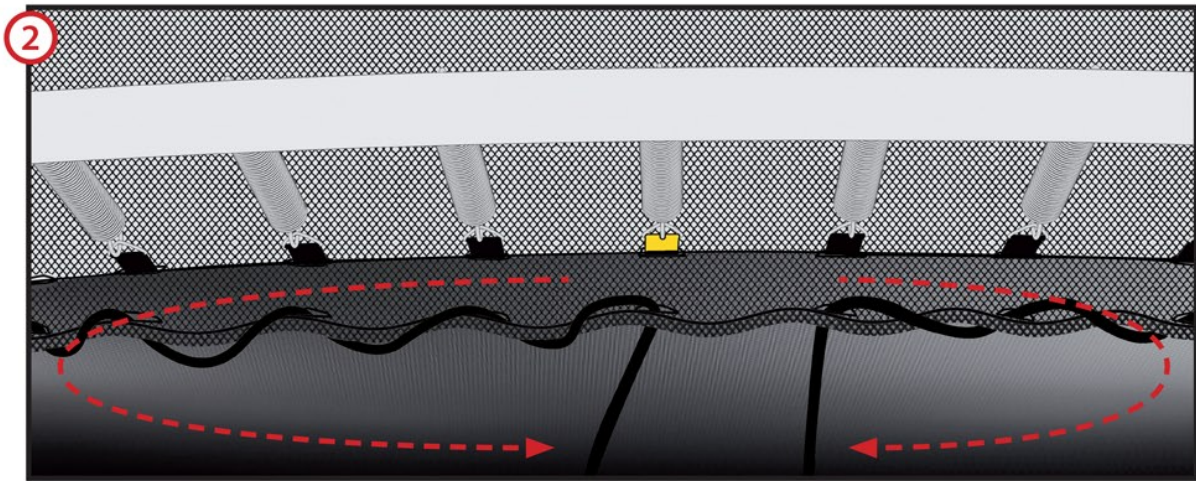
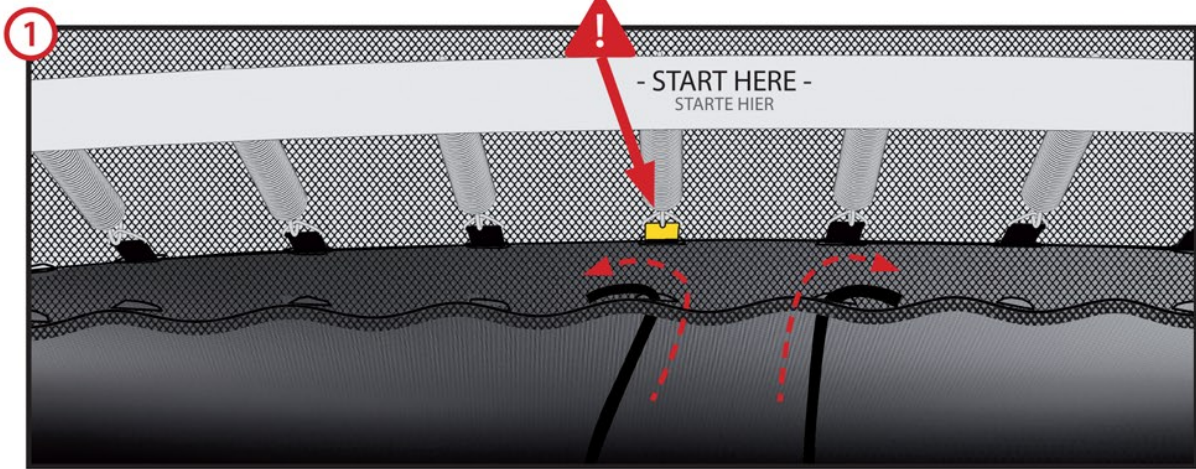
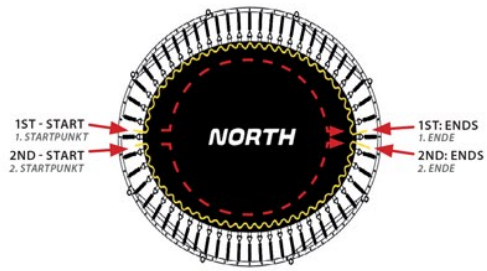

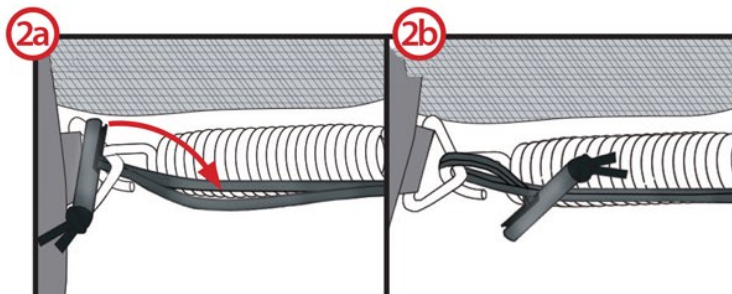
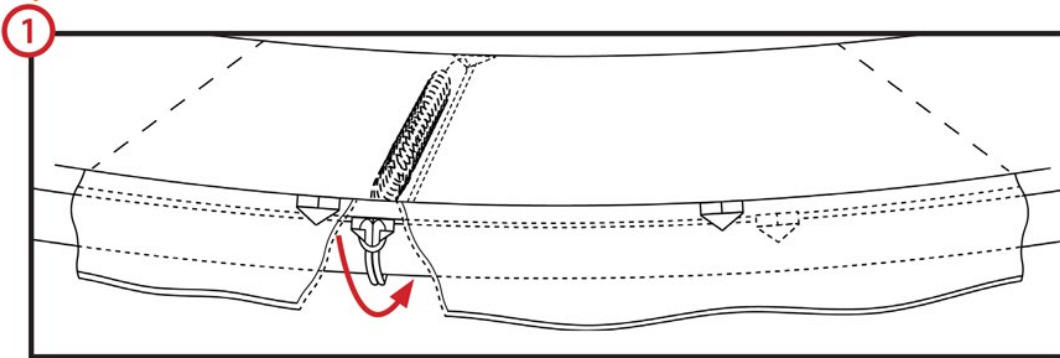
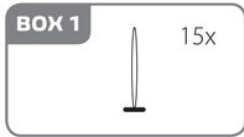

x15

